



**Getting Started With  
Your  
AQUALITE RO/DI Water  
Purification System  
(In full color at [www.aquathin.com](http://www.aquathin.com))**

**Includes setup and maintenance information for:  
AQUALITE Ultra Deluxe**

**AN ISO 9001:2008 QMS  
REGISTERED /CERTIFIED COMPANY  
(IMS-0192 & NQA-12635)**

© 2007-2016 Aquathin Corporation. All rights reserved.

Under the copyright laws, this manual may not be copied, in whole or in part, without the written consent of Aquathin Corporation.

Every effort has been made to ensure that the information in this manual is accurate. Aquathin Corporation is not responsible for printing or clerical errors.

## **Aquathin Corporation**

Aquathin Business Centre  
950 South Andrews Avenue  
Pompano Beach, Florida 33069  
1-800-GO.2.RODI (462-7634) or 1-954-781-7777  
Fax: 1-954-781-7336  
Email: [info@aquathin.com](mailto:info@aquathin.com)  
[www.aquathin.com](http://www.aquathin.com)

Aquathin Corporation, the Aquathin Corporation logo, AQUALITE RO/DI Water Purification System, Platinum -90, and PSS-90 are trademarks and copyright of Aquathin Corporation. Product specifications are subject to change without notice.

### **Your Authorized Aquathin Dealer Is:**

Dealer Name \_\_\_\_\_  
Contact \_\_\_\_\_  
Address \_\_\_\_\_  
\_\_\_\_\_  
Phone \_\_\_\_\_  
Fax \_\_\_\_\_  
Email \_\_\_\_\_

# Introduction

*Thank You* for your purchase. Aquathin turned **"30 in 2010" to enjoy its Pearl Anniversary** and it's a great feeling of self satisfaction and accomplishment to be an Authorized Aquathin Dealer. You could not have picked a better time to consider the many benefits of becoming a member of the ever growing Aquathin Family. The Next Quarter Century Celebration Begins!

*Aquathin has earned 7 Patents and manufactures a broad spectrum of unique and proprietary water purification, softening and filtration systems servicing the residential, commercial and laboratory markets. Established in 1980, Aquathin now produces over 70 proprietary and trademarked devices for markets around the world through more than 600 Authorized Aquathin Dealers. Aquathin is an E.P.A. Registered manufacturer, ISO 9001:2008 Certified and recipient of the prestigious President's Excellence Award in Export from the U.S. Commerce Department and the Nation's Blue Chip Enterprise Initiative Award from the U.S. Chamber of Commerce. We have a very impressive global client list that now includes you and your family. Recently we have launched a project, two years in the making, for Authorized Aquathin Dealers to provide total home air and water security...and more. Visit the Aquathin Allergy Store online at [www.aquathin.com](http://www.aquathin.com).*

*Aquathin does not sell franchises nor do we charge for territories. We want to make sure that our Dealers are service oriented and knowledge driven. We know that even though we make the best water treatment systems in the world, ultimately they are only as good as the people representing them. And this is why we make the very best water treatment Dealers in world. Your local Authorized Aquathin Dealer has received training and continuous education from Aquathin University. You can be assured that when you purchase from an Authorized Aquathin Dealer (or from the factory directly in areas where we have yet to approve and establish a Dealer) you are receiving the finest equipment and technical support this industry is able to offer. Highest quality water treatment systems and support good enough for my home...my family.*

*And that is my promise to you! I love my Aquathin!!*

**FOR THE BEST TASTE IN LIFE &  
35 Years Pure Excellence**

*...and another Quarter Century re-inventing the water industry!  
Think Aquathin...AquathinK !!  
( visit the **NEW** [www.aquathin.com](http://www.aquathin.com) )*

*"Alfie"*

*Alfred J. Lipshultz, President*

*P.S. Remember...the next best thing to owning an Aquathin is recommending one to a friend!*

# C o n t e n t s

<b>1</b>	<b>Getting Started</b>	<b>7</b>
	<b>Setting Up Your AQUALITE System</b>	<b>8</b>
	1. Unpack the System	9
	2. Required Tools	10
	3. Planning the Installation	10
	4. Installing the Chrome Faucet Assembly	10
	5. Installing the Feed Water Saddle Valve	11
	6. Installing the Drain Saddle Valve	12
	7. Preparing to Mount the Main Assembly	13
	8. Making the Tubing Connections	14
	9. Connecting Tubing to Speedfit® Fittings	15
	10. Connect Cold Water Supply Line	15
	11. Connect the Drain Line	16
	12. Mount the Main Assembly	16
	13. Prepare Storage Tank	17
	14. Connect Main Assembly to Storage Tank	17
	15. Connect GAC Post Filter	18
	16. Power-up the Main Assembly	18
	17. Connect to Ice Maker – optional	18
	18. Option for Low Source Pressure (PBA-G)	19
	<b>Verify the Tubing and the Flow</b>	<b>19</b>
	<b>Starting Your System</b>	<b>20</b>
	<b>Indicators of System Activity</b>	<b>21</b>
	<b>Operation Procedure</b>	<b>23</b>
<b>2</b>	<b>Getting to Know Your RO/DI System</b>	<b>24</b>
	<b>A Look at the Key Components</b>	<b>24</b>
	Aquathin CARB 12 Two-Stage Pre-filter	24
	Granular Activated Carbon	25
	Aquathin Reverse Osmosis Module	25
	Aquathin Deionization Module	26
	<b>Operating Parameters</b>	<b>27</b>
	Pressure	27
	pH	27
	Chlorine and Chloramines	27

	Sediment	28
	Iron	28
	Hardness and More	29
<b>3</b>	<b>Maintenance And Servicing</b>	<b>31</b>
	Exterior Cleaning	31
	Flushing	31
	Filter Replacement	32
<b>4</b>	<b>Frequently Asked Questions</b>	<b>37</b>
<b>5</b>	<b>Limited Warranty</b>	<b>41</b>
	What The Warranty Covers	41
	Exceptions To Lifetime Warranty	41
	What We Will Do To Correct An Inconvenience	42
	How State Law Relates To The Warranty	42
<b>A</b>	<b>ppendix A - Specifications</b>	<b>43</b>
<b>A</b>	<b>ppendix B - Replacement Schedule</b>	<b>45</b>
	Replacement Components	45
	Maintenance Log	46
<b>A</b>	<b>ppendix C - Connections</b>	<b>47</b>
	C1—Sink Mounted Faucet Assembly	47
	C2—John Guest Speedfit® Fitting	48
	C3—AQUALITE Installation Diagram	49
	C4—AQUALITE Installation (with pump)	50
	C5—Schematics	51
<b>A</b>	<b>ppendix D - Optional Pump</b>	<b>52</b>
	1. Prepare to Mount the Pump	52
	2. Connect Pump Inlet to Feed Assembly	53
	3. Connect Pump Outlet to CARB 12 pre-filter	54
	4. Mount the Pump	54



CHAPTER

# 1

## **GETTING STARTED**

Thank you for purchasing this quality water purification system by Aquathin Corporation. The Aquathin AQUALITE Ultra Deluxe RO/DI is the ultimate sophisticated state of the art in water purification and began production in the early 1990's after successful lab testing and 20 year field experience. This user's manual serves for the installation of the AQUALITE Ultra Deluxe RO/DI. Every Aquathin AQUALITE Series system combines several efficient methods of water treatment to achieve a very specific result—pure water that meets the rigorous standards for biocompatibility.

As the new owner of an Aquathin RO/DI water purification system there is a totally new experience awaiting you. You and your family will be amazed at the delightful new taste of your tap water—it's like owning your own personal mountain spring.

This manual provides information about the application and servicing of your Aquathin water purification system. Descriptions of the components and their functions will help to answer frequently asked questions. By thoroughly reading this manual you will be better able to operate your new system and perform simple maintenance.

## **SETTING UP YOUR AQUALITE SYSTEM**

Your Aquathin AQUALITE system requires adequate water pressure. The AQUALITE operates at 24 volts, utilizing a compact transformer that accommodates either 110 or 220 volts, so that you can take your system wherever you move. This unit is designed to operate within a pressure range of 40–100 PSI. The amount of purified water produced depends primarily on your water pressure, temperature, and the amount of Total Dissolved Solids (TDS). Normal production averages up to 45 gallons ( $\approx$  170 liters) per day. If you plan to install this unit on a private well system, you should check your water pressure gauge. If the low pressure setting is less than 40 PSI, ask a plumber to adjust and raise the pressure to the minimum level of 40 PSI. An optional booster pump (PBA-G) is available when source pressure is severally low. Installation to comply with state and local laws and regulations.

### **IMPORTANT NOTE:**

For private well owners we recommend that you choose the AQUALITE Ultra Deluxe with PBA-G booster pump system which includes a booster pump and is completely configured at the factory. This eliminates fluctuations in line or low pressure associated with private wells and ensures your AQUALITE system operates at peak efficiency. While 45PSI is enough to produce water with exceptional purity required for passing Aquathin standards, you may find water flow to the faucet is less than optimal, and that your holding tank will not store much water. (The amount of water stored is a function of line pressure).



## Installing Your AQUALITE System Requires the Following Steps:

- ◆ Install the sink-mounted chrome faucet.
- ◆ Install the feed water saddle valve to deliver tap water to your system.
- ◆ Mount the Frame Assembly to the cabinet sidewall (optional).
- ◆ Make the tubing connections.
- ◆ Install the Platinum Booster Assembly (PBA-G) to provide ample water pressure (optional).

### 1. Unpack the System

*Contents include:*

1. Main filter assembly, with sub-sink frame, including the RO module, DI module and Sediment /Carbon pre-filter (CARB 12)
2. Faucet assembly
3. Storage tank
4. Tank ball valve
5. Feed water saddle valve
6. Drain saddle valve
7. GAC post filter (CARB 6)
8. Ice maker tee (optional)
9. Platinum booster assembly, including pump and pressure gauge (optional)
10. Tubing



**Figure 1. Package Contents**

## 2. Required Tools

Hi Speed Drill	#2 Phillips Screw Driver
¼" High Speed Drill Bit	Teflon thread tape
½" High Speed Drill Bit	Razor knife with fresh sharp blade
¼16" High Speed Drill Bit	Adjustable (Crescent) Wrench
For porcelain sinks, a Dremmel® tool and ¾" silicon carbide grinding wheel or a Glass & Tile carbide spade-tipped bit.	For granite counter-tops, you will need to have a professional drill a ½" hole.

## 3. Planning the Installation

Review the following instructions completely before proceeding. (See [installation diagram on page 49.](#)) Aquathin AQUALITE systems are comprised of several compact components which fit easily beneath most kitchen sinks. We encourage you to establish the desired location of each of the components before proceeding. Installing the main assembly against the left sidewall is recommended whenever possible. The storage tank has built-in feet for upright positioning and it can be placed on its side when space is limited. (A stand is included.)

## 4. Installing the Chrome Faucet Assembly

- 1) Select a location for the faucet on the sink top.

NOTE: Make sure there are no reinforcing ribs under the sink drilling location.



*Figure 2. Pure water faucet on sink*

2) Use factory approved method or approved plumbing practice to drill a 7/8" hole in the sink.

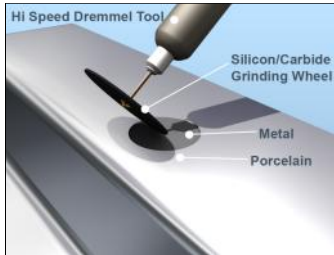

**Figure 3. Using a Dremmel Tool to remove porcelain**

Porcelain sinks: factory approved method is: first grind away porcelain with a Dremmel® tool and silicon grinding wheel (about 3/4" circle).

Then, use a standard 1/2" high-speed drill bit to drill hole through metal portion of sink. (insert figures) Alternately, use a "glass and tile carbide spade tipped bit."

Acrylic sinks: use 1/2" high-speed drill bit.

Stainless Steel sinks: use 1/2" high-speed drill bit or 1/2" Greenlee chassis punch.

3) Install faucet according to detailed diagram in [Appendix C1, page 47](#), insuring rubber gaskets are in place.

4) Tighten lock nut beneath sink. Save compression fitting parts for connection to GAC post-filter.

## 5. Installing the Feed Water Saddle Valve

The saddle-type valve supplied is intended for use on 3/8" to 1/2" copper tubing cold water supply line. It is not intended for flex lines.

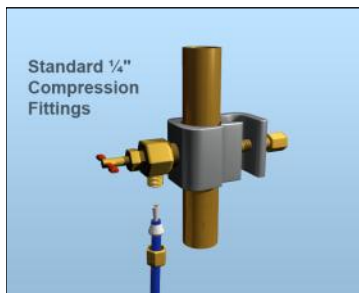

**Figure 4. Feed water saddle valve.**

**Install on cold water line only!**

**NOTE: Color coding of tubing is for installation purposes.**

Turn off the cold water valve under the sink or the main valve for the house. Slide clamp over the copper tubing and tighten screw firmly to hold the clamp in position. Pierce the copper tubing by turning the needle valve handle clockwise until it is firmly seated. The valve is closed in this position. Turn on the MAIN supply valve to pressurize cold water line. Immediately check for any signs of leaks. Set aside compression fittings for later use in connecting feed tubing to system.

When ready to supply water to the system, turn valve handle counter-clockwise until fully open. In some instances the self-piercing valve provided will not be compatible with your plumbing. We have provided a feed valve that will satisfy most scenarios. Alternate parts using standard ¼" compression fittings can be found at a plumbing supply or at home improvement stores. On rare occasions, it may be necessary to contact a plumbing contractor to complete your installation.

## 6. Installing the Drain Saddle Valve

The drain saddle assembly should be installed above the trap and on the vertical or horizontal tailpiece. (See [Figure 5](#)). Refer to [Figure 6](#) (next page) and

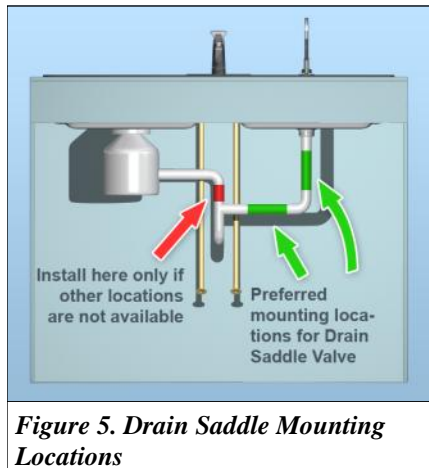

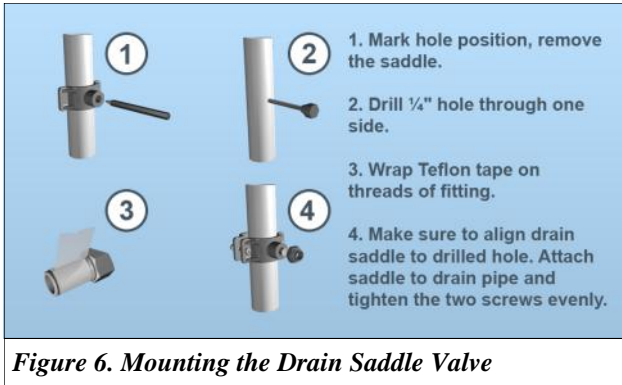

follow steps 1 through 4 to mount the drain saddle valve.

NOTE: When installing the Main Assembly, mount the frame above the position of the drain saddle whenever possible. (See Figure 11 on page 16).

## 7. Preparing to Mount the Main Assembly

When possible we recommend mounting the main assembly on the left sidewall of the cabinet, but this is not a requirement. ***It is not required that the system be mounted at all***—many owners choose to let the main assembly

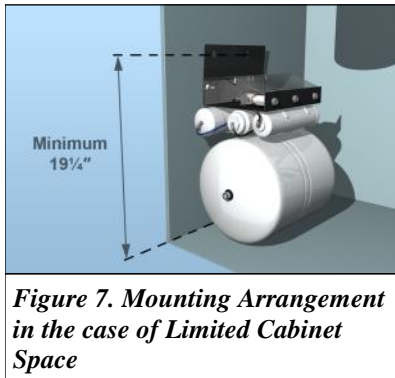

stand unsupported on the floor of the cabinet. Mounting the system as shown in Figure 7 will not only save cabinet space, but also the brackets on the bottom of the frame will cradle the tank holding it in position.

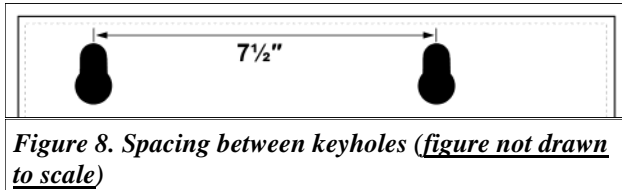

**Figure 8. Spacing between keyholes (figure not drawn to scale)**

Install the screws (Figure 8) provided allowing for the thickness of the frame. (A pilot hole using a 1/16" drill bit is recommended for particle board side-walls.)

NOTE: Do not hang the assembly until tubing connections have been made (following pages.)

## **8. Making the Tubing Connections**

You have completed the bulk of the installation tasks. All that remains is connecting tubing between the components.

The tubing is to be used to:

- Connect the feed water saddle valve to the inlet on the main assembly (indicated by "TO FEED")
- Connect the chrome faucet to the inlet on the main assembly frame (indicated by "TO DRAIN")
- Connect the tank to the inlet on the main assembly (indicated by "TO TANK") and as well to connect the tank to the faucet through the GAC post filter (CARB 6).

NOTE: It is important to correctly measure the required length of the tubing for each connection prior to cutting the tubing. Additional yellow and red tubing are provided if you opted for the pump (PBA-G).

## 9. Connecting Tubing to John Guest *Speedfit*® Fittings

Aquathin systems make extensive use of John Guest *Speedfit*® fittings. These high quality components provide secure, leak free seals and make it easy to connect and disconnect tubing without the use of tools. Refer to [diagrams on page 48, Appendix C2](#).

## 10. Connect Cold Water Supply Line

Measure and cut a length of tubing to connect the feed water saddle valve to the left inlet on the frame assembly (indicated by “TO FEED”).

Connect the tubing to the saddle valve using the compression fittings provided. (See [figure 9 and installation diagram on page 49](#).)

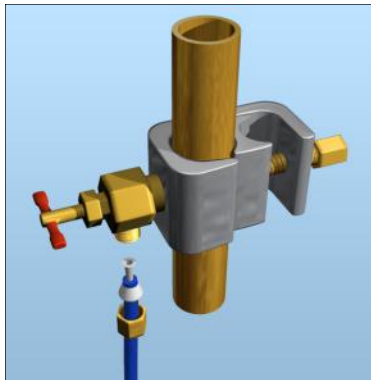

**Figure 9.** Connect tubing as shown (color coding of tubing is for installation purposes)

Cut tubing so the end is square to ensure a leak free seal. Cut tubing with a fresh, sharp blade and a slicing motion to avoid crimping. See [figure 10 on the right](#).

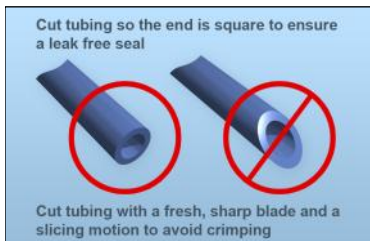

**Figure 10.** Cut tubing square; do not use scissors

## 11. Connect the Drain Line

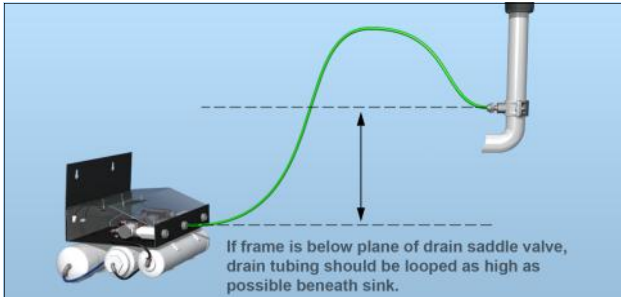

***Figure 11. Drain line connection (color of tubing is for illustrative purposes)***

Measure and cut a length of tubing to connect the drain water check valve (indicated by “TO DRAIN” on the frame assembly) to the drain water saddle valve.

**IMPORTANT:** Be sure to measure the tubing appropriately before cutting. If the frame of the main assembly is not above the drain saddle valve, you will need to loop the tubing as high as possible beneath the sink. Be sure to allow for this loop when you measure. A self-adhesive tubing clip has been provided to secure the drain loop.

## 12. Mount the Main Assembly

With the cold water supply and drain line connected, the main assembly can now be placed onto the screws previously installed. Place the keyhole openings over the screws then slide the frame horizontally onto the mounting screws. You may wish to remove the main assembly and adjust the screws to make the connection as secure as possible.



### 13. Prepare Storage Tank

Remove the plug on top of the storage tank, revealing an inlet. Wrap Teflon pipe tape on the threads of the storage tank inlet; then place three (3) drops of regular household chlorine bleach into the opening. Attach the tank

Wrap pipe tape on threads. Follow label instructions to ensure disinfection before attaching tank ball valve. Close valve to prevent chlorine from escaping.



**Figure 12. Storage tank preparation**

ball valve as shown in the **figure above**. Close valve to prevent chlorine from escaping.

Close the tank ball valve by turning the blue handle perpendicular to the valve body; then screw the valve onto the storage tank until firm. **DO NOT OVERTIGHTEN**. Determine the position for the storage tank beneath the sink. If space is at a premium, it is OK to lay the tank on its side. A stand is included.

### 14. Connect Main Assembly to Storage Tank

With the tank in position, measure and cut a length of tubing to connect the inlet of the main assembly indicated by “TO TANK” and the “T” connector on the tank ball valve. (See **figure 13.**)

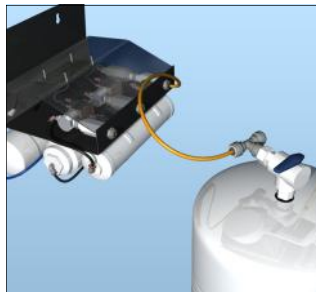

**Figure 13. Main assembly to storage tank (color of tubing is for illustrative purposes)**

## 15. Connect GAC Post Filter

Refer again to the AQUALITE [installation diagram on page 49 in Appendix C3](#). The GAC post-filter (**CARB 6**) is typically installed just below the faucet assembly and is easily supported by the tubing and Speedfit® fittings.

Measure and cut a length of tubing to connect the outlet of the GAC post-filter to the faucet assembly. Placing the post-filter near the tank will make it easy to service when needed.

Connect one end of the tubing to the threaded stem of the chrome faucet assembly using the ¼" compression fittings provided. (See [diagram on page 49 in Appendix C3](#).)

Connect the opposite end of the tubing to the outlet of the GAC post-filter.

Finally, measure a length of tubing to connect the storage tank to the GAC post-filter.

Leave the handle on the tank ball valve closed at this point.

## 16. Power-up the Main Assembly

Connect the provided transformer to the main assembly as shown.

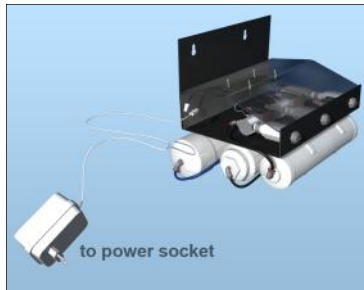
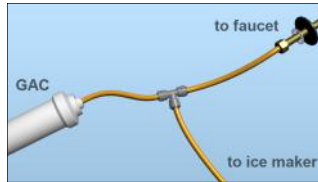

**Figure 14. Transformer connection**

## 17. Connect to Ice Maker – optional

Before connecting the GAC post-filter to the faucet assembly (as described above), connect the GAC post-

filter to the ice maker using the Ice Maker Tee provided. (See figure on the right.)



### 18. Option for Low Source Pressure (PBA-G)

If you experience fluctuations in line or low pressure, often associated with private wells, we recommend that you choose the AQUALITE with PBA-G booster pump system which includes a booster pump and is completely configured at the factory. (The amount of water stored is a function of line pressure). To setup and install the optional pump, refer to [instructions in Appendix D](#).

*Figure 15. Connect the Ice Maker as shown (color of tubing is for illustrative purposes)*

## VERIFY THE TUBING AND THE FLOW

Tubing and flow depend on whether you chose to use the pump.

### Without pump:

Cold water enters the main assembly through the “TO FEED” inlet. The water then passes through to the inlet of the CARB 12 pre-filter and from the pre-filter to the RO Module.

The purified water exits the main assembly from the “TO TANK” outlet and passes through the tank and the CARB 6 GAC post-filter before reaching the chrome faucet.

### With pump:

Cold water enters the main assembly through the “TO FEED” inlet. The water then passes through the pump to

the inlet of the CARB 12 pre-filter before reaching the RO module.

The purified water exits the main assembly from the “TO TANK” outlet and passes through the tank and the CARB 6 GAC post-filter before reaching the faucet.

Congratulations! You have completed the installation of your Aquathin AQUALITE water purification system. You are now ready to begin making pure, Aquathin quality drinking water.

## **STARTING YOUR SYSTEM**

1. Open the chrome faucet on the sink top.
2. Verify the Tank Ball Valve is closed.
3. Slowly open your cold water supply valve. You will also begin to hear water flowing into the drain.
4. Check the pressure gauge on optional PBA-G. Record your initial pressure in Appendix B.
5. In approximately 20 minutes you will begin to see water drip from the faucet.
6. Close the faucet on the sink top, and then quickly open the Tank Ball Valve to allow the storage tank to fill. Actual production rate will vary slightly depending on pressure, but your system will normally produce up to 45 gallons of water per day, depending on model. The first tank of water may take longer.
7. **DISCARD THE FIRST FULL TANK OF WATER.** Open the faucet and let the water flow until only a trickle remains. Close the faucet and allow the tank to fill a second time. You are now ready to enjoy the great taste of 100% pure, Aquathin drinking water. (The RO Module contains a preservative solution that will be flushed after the first tank of water is produced.)

**IMPORTANT:** Monitor your system and check for leaks frequently over the first week.

Most leaks are attributed to tubing not fully seated inside the Speedfit® fittings. Remove the red lock clip, compress the collet, and remove the tubing. Re-insert the tubing until you feel it bottom out on the tubing end-stop. Replace the red lock clip. This process solves 99% of leaking connections. If the leak persists, trim ¼" – ½" off the end of the tubing and try again.

## **INDICATORS OF SYSTEM ACTIVITY**

The main system has four light indicators on the frame. These are important indicators of the system activity.









The **first green light** (from left) indicates that the power is turned on. This light appears when the system is running, filling, or flushing. It remains lit even when the tank is full and when the pressure is low.

The **second green light** (from left) turns on only when the tank is full. Therefore, when the tank is full, both the green lights will be lit.

The **first amber light** (from left) is lit when the system is active, i.e. when water is either filling or when the system is flushing. Therefore, if the tank is full and the system is idle this light will not be lit.

The **second amber light** (from the left) is lit only when the system is flushing; flushing is an automated function in the AQUALITE Ultra Deluxe.

The **red light** indicates that the water pressure is low. If this light is turned on, you may need to use the optional pump system.

	<b>Green</b> (power on)	<b>Green</b> (storage tank full)	<b>Amber</b> (system on/off)	<b>Amber</b> (system flushing)	<b>Red</b> (low feed pressure)
<b>System running</b>					
<b>System flushing</b>					
<b>Tank full</b>					
<b>Low water pressure</b>					

## **OPERATION PROCEDURE**

Your Aquathin Auto Power Panel Subsink Reverse Osmosis / Deionization Water Purification System is self operational. The exclusive patented power panel does all the work! Each time the tank calls for water, the system will self flush the RO Module for 2 minutes and then manufacture water. Unlike other RO systems, this unique design helps to preserve the longevity of your RO Module by removing potentially plaquing debris.

**NOTE: Should you leave your residence for a few days or more, turn off the cold water feed line, unplug the electric cord, and drain the tank via the faucet. Repeat the start up procedure when you return.**

## **GETTING TO KNOW YOUR AQUATHIN RO/ DI SYSTEM**

Your Aquathin AQUALITE system combines the three most effective water purification technologies available. Alone, each of these methods is highly effective for a particular group of pollutants—but only when combined can you be assured of complete removal of all contaminants. Every system combines Carbon Adsorption, Reverse Osmosis, and Deionization. By carefully matching the components utilizing these methods, we are able to assure your system produces water which meets or exceeds the standards for biocompatibility and purity.

### **A LOOK AT THE KEY COMPONENTS**

#### ***Aquathin CARB 12 Two-Stage Pre-filter***

This fully encapsulated filter module contains a carefully chosen grade of granular activated carbon to remove chlorine, chloramines, and other organic contaminants along with a nominal 10-20 micron sediment filter to remove silt, sand, rust, or other deposits commonly found in the feed water supply. This protects the Aquathin Reverse Osmosis Membrane from particles



which might clog the pores. This pre-filter has been carefully selected for its extremely high dirt holding capacity.

Before water reaches the reverse osmosis module, it is subjected to a “Aquathin unidirectional” Granular Activated Carbon pre-filter. Flow is lengthwise, not radial, for maximum contact time and organic adsorption. Through the two-stage pre-filter we insure complete removal of organic contaminants including pesticides, herbicides, and other hydrocarbon based compounds.

A single gram of steam washed, bituminous grade, granular activated carbon typically has  $\approx 1500$  square meters of surface area—meaning our 2-stage CARB 12 pre-filter provides over 200 acres (0.81 square kilometers) of surface area where organic contaminants dissolved in the water have an opportunity to be adsorbed and eliminated. This immense GAC surface area also insures complete and total conversion of chlorine and chloramines—protecting the Aquathin polyamide—thin film composite (TFC) Reverse Osmosis Module downstream.

### ***Aquathin Reverse Osmosis Module***

A custom designed and extremely efficient High Flow spiral wound Reverse Osmosis Module produces up to 45 gallons ( $\approx 170$  liters) of purified water per day. The Aquathin RO Module utilizes the unique properties of a semi-permeable material which allows passage of pure water molecules while not allowing dissolved salts, heavy metals, organics and disease causing water-borne microorganisms to pass through.

Our extraordinary module is designed to consistently and significantly reduce the total dissolved solids in the source water supply by greater than 97%. It also has a

tremendous capacity to completely reject organic and biological contaminants, including disease causing water-borne microorganisms. EPA EST. NO. 52531-FL-01

The Aquathin Reverse Osmosis Module used in this system can tolerate significantly higher concentrations of oxidizing contaminants like iron and manganese than RO modules found in other systems, as well as a much higher degree of hardness. However, there are limitations—the operating parameters for this module are found in the Specifications section of this manual.

### ***Aquathin Deionization Module***

This stage contains a unique blend of proprietary deionization resins carefully matched to our Reverse Osmosis Module and provides superior rejection of monovalent ions, fluoride, and nitrates; contaminants only partially removed by reverse osmosis. Including deionization after reverse osmosis sets Aquathin systems apart from other ordinary RO systems.

Following the DI resins, there is even more granular activated carbon to polish the product water for a clean, fresh taste. The flow rate at this stage provides tremendous contact time to assure complete removal of any remaining organic contaminants.

The final stages of our proprietary DI module are included to prevent the reverse migration of contaminants into the system. These stages further separate Aquathin systems from other brands. After carefully combining the previous components it is essential to integrate these stages to ensure 99.999% removal of bacteria, cyst, and virus (EPA EST. No. 52531-FL-01). These stages also prevent any contaminants from entering the system via the faucet.

## **OPERATING PARAMETERS**

To insure proper operation of your AQUALITE system, it is advisable to collect the following information about your water supply. This information is generally available from your municipal water department, and in many cases is available from the website of your local Department of Public Works.

### ***Pressure***

In order to overcome the natural osmotic force, adequate water pressure must be available from your water supply. The osmotic force is directly proportional to the concentration of dissolved solids in the water. When the water pressure is equal to the osmotic force, there will be no movement of pure water molecules across the semi-permeable reverse osmosis module. A minimum of 45 PSI is required. (If your water pressure is below 45 PSI, a booster pump is available. If you are on a private well, have your plumber raise the minimum pressure above 45 PSI.)

In general, the higher the pressure (up to 100 PSI), the better the performance of the module at rejecting contaminants.

### ***pH***

The Aquathin HRO TFC module will hold up very well when the pH of the feed water is between 2 and 11. Water supplies with pH over 11 are very rarely, if ever, found. (Chlorine bleach has a pH of ~11.5.)

### ***Chlorine and Chloramines***

Chlorine is the most common substance added to municipal water supplies. Its purpose is to eliminate biological growth (i.e. chlorine is toxic). Regulations usually require there be residual chlorine when water

reaches your tap. Typically, the residual concentrations of chlorine in household water range from 0.5 to 1.0 parts per million (ppm).

Besides being toxic, chlorine and chloramines will degrade the TFC Reverse Osmosis Module. Therefore, it is essential to remove chlorine from your feed water before it reaches the RO Module. Your Aquathin RO/ DI system includes a pre-filter containing a special grade of grade of Granular Activated Carbon (GAC) which will very effectively remove chlorine and chloramines from your tap water. It is important to replace the pre-filter annually to insure no chlorine is reaching the membrane.

### ***Sediment***

In areas with very high sediment concentrations the Aquathin pre-filter may clog prematurely. If the pre-filter becomes clogged, you will likely notice a decrease in the production rate from your system. In areas with very high sediment concentrations, it may be necessary to replace the pre-filter on a semi-annual basis.

Over the course of one year, the sediment filter will typically become significantly discolored. This is not cause for alarm. If you notice pressure at the gauge has dropped significantly below your initial observations, consider changing this filter to restore adequate pressure and improve overall system performance.

### ***Iron***

Iron concentrations greater than 0.1 mg/l can degrade overall system performance. If your water supply has iron concentrations above 0.1 mg/l, pretreatment is recommended for ordinary RO systems. Your patented Aquathin process will tolerate up to 3 ppm iron.

### ***Hardness and More***

Two thirds of the water on earth is groundwater. As it travels through rock and soil it picks up particles of calcium, magnesium, iron, lead, and other minerals. For 85% of the country, that translates into “hard water”. “Hardness” refers to the amount of calcium and magnesium in the water and is measured in grains per gallon (gpg). The following guide defines your water’s hardness based on two different measurements. Our test determines the grains of hardness that can easily be converted into the ppm.

<b>Description</b>	<b>Grains of Hardness</b>	<b>Parts per Million</b>	<b>Laundry Detergent Required</b>
<b>Soft (ideal)</b>	0.0—1.0	0—18	1/4 dispenser
<b>Slightly Hard</b>	1.0—3.5	18—60	1/4 dispenser
<b>Moderately Hard</b>	3.5—7.0	60—120	1/2 dispenser
<b>Hard</b>	7.0—10.5	120—180	1/2 dispenser
<b>Very Hard</b>	10.5—over	180—over	Full dispenser

Most of the problems associated with hard water are economical in nature. Hardness causes unsightly soap scum on fixtures, water spots on glasses and whitish scale deposits in your tubs and showers. Hard water means you use more soap and cleaning agents because they first have to “clean” the water before they clean anything else.

**H**ere is a little additional information about the ordinary RO systems sold in hardware stores and wholesale clubs:

1. They state their systems must be installed on water with less than 10 grains of hardness. Otherwise you need an expensive water softener just for the RO system. Your Aquathin can be installed on hard water up to 25 grains due to the patented flush.
2. There is a disclaimer that those units may not be installed on microbiologically unsafe water. But would that not be a reason one would purchase a system? Your Aquathin will remove disease causing waterborne microorganisms.
3. Their warranty is one year, but does not cover the RO module, yet that is the heart of the unit. When service is needed, you must ship the system out of town. Some require the module to be replaced every 6 months according to them. Your Aquathin carries a Lifetime Warranty except for normal filter changes and abuse.

**Y**ou originally invested in your Aquathin to provide your family the very best in total home water security. There is hardly anything in this world that a man could not make a little worse or a little cheaper, and the people who consider price alone are this man's lawful prey. It's like this: we would rather explain price once than apologize for poor quality and service the rest of our life. In 1980 Aquathin made the decision at the onset; that we would never sacrifice or lower quality for price... too much depends on it. Would you prefer that your family drink from a system whose poor technology and cheap design allows them to continue to consume contaminates... or a product that provides the safest and most pure drinking and cooking water available?

***I LOVE MY AQUATHIN!***

## MAINTENANCE AND SERVICING

Minimal work is required to keep your Aquathin AQUALITE system in peak operating condition. Simply replace the filter modules as recommended. These simple steps will insure your unit consistently produces ultra-pure water meeting Aquathin standards.

Take care of your Aquathin system and it will provide many years of healthy drinking and cooking water for your entire family.

### **1. Exterior Cleaning**

The exterior surface of your Aquathin can be kept looking like new by occasionally cleaning the surfaces with a soft cloth. Great care was taken in the choice of material for your unit, but the cabinet cannot withstand harsh chemicals or solvents. Use a mild, non-abrasive dish washing detergent or diluted spray cleaner to remove smudges or food stains, then rinse and dry the surface. Use of abrasive scouring powders or glass cleaning products containing ammonia are not recommended.

### **2. Flushing**

Flushing is the single most important maintenance function needed to keep your system operating at peak

efficiency and it extends the service life of the reverse osmosis module. This simple operation has been automated in the **Aquathin AQUALITE Ultra Deluxe**.

If your unit has not been used for more than one week (e.g. while you are on vacation), drain the storage tank (use the water for watering plants, etc.) then flush the module for 5-10 minutes as described above.

### **3. Filter Replacement**

After 12 months of use, it is time to replace the 2-stage Aquathin CARB 12 pre-filter and the 4-stage Aquathin Deionization (DI) Module to insure your system is producing water within RO/DI parameters. After 2-3 years (depending on the level of contaminants in water), the Reverse Osmosis (RO) Module should be replaced, along with the post filter (CARB 6). Replacement modules can be ordered directly from your local Authorized Aquathin Dealer.

1. Remove the contents from beneath the kitchen sink where the Aquathin assembly is located.
2. Choose a work area with a large flat surface such as a kitchen table.
3. Place a soft clean towel on the working surface – it will absorb the small amount of water that will spill from the modules as they are changed out, and it will protect the surface of both the table and your Aquathin cabinet.
4. Turn the unit over on the towel, exposing the filter modules

### **Removing the Aquathin Modules**

Before proceeding, [refer to Appendix C2 on page 48](#).

Remove the tubing connections to the Aquathin Modules (CARB 12, DI Module and RO Module) – NOTE: refer to the [figure 16](#) on how to release tubing and follow the



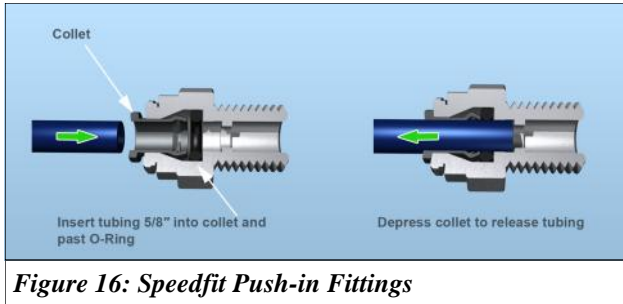

procedure outlined:

1. The first module you need to remove is the 2-stage Aquathin CARB 12 pre-filter. It is supported by two “Double C” clamps which are attached to the Aquathin RO Module. At one end of the CARB 12 pre-filter the feed water tube enters from the feed assembly. At the other end a piece of tubing connects to the feed water inlet of the RO Module.

The tubing is attached to the module using a unique push-in fitting system (figure 16). This system is designed to make connecting and disconnecting filter modules very easy while insuring a water tight connection.

The “collet” assembly will securely hold the tubing in place under normal operating conditions. Pulling on the tubing will not cause it to release, instead the “grip” of the collet will become more secure. An O-ring behind the collet assures a leak free seal.

To insure your system will be water-tight even after being shipped across country, we have inserted small plastic retaining clips on each fitting. These are easily removed with your fingers or, if grabbing the clip is difficult, you may wish to use a pair of needle-nose pliers.

2. Remove the retaining clips from each end of the Aquathin CARB 12 pre-filter, then remove the tubing itself. You will feel some resistance as the tubing slides away from the O-ring inside the fitting.
3. With the CARB 12 free of its connections, it can now be removed from the two “Double C” clamps holding it to the RO Module. **Note the direction of the “FLOW” arrow. You will need to install the new CARB 12 pre-filter in the same orientation.** Refer to Figure 18 for steps 4—6.
4. After removing the CARB 12, you can easily remove the two “Double C” clamps and set them aside. With the CARB 12 pre-filter removed, you now have access to the Aquathin DI Module and the RO Module. These two modules are attached with a custom clamp arrangement secured by two wing nuts. Before removing the wing nuts, you need to disconnect several more tubes from their fittings.

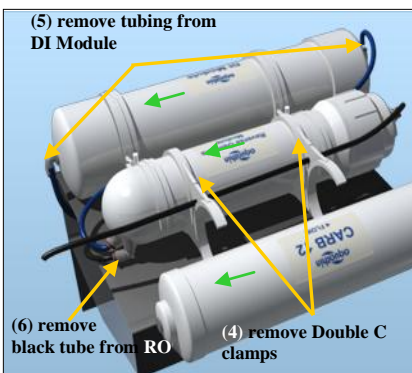

**Figure 18: Steps 4-6**  
**NOTE: the green arrows show you the flow for each module**

5. Disconnect the tubing from each end of the Aquathin Deionization (DI) Module. **Note the direction of the “FLOW” arrow. You will need to install the new DI module in the same orientation.**

6. One end of the Aquathin Reverse Osmosis module has two connections—one blue tube connects to the Aquathin DI Module, and one black tube connects to the Aquathin drain valve assembly. Remove the black tube from the RO Module.
7. You can now remove the two wing nuts which secure the RO Module and DI module to your Aquathin cabinet. See figure 19.



**Figure 19: Remove the two wing-nuts**

8. You are now ready to remove the RO Module and DI Module from the housing.  
**Note:** If this is the first time you are replacing the DI Module, you will find both the DI Module and RO Module are secured to the clamps with double sided adhesive tape (installed to prevent shifting and damage during transit). The adhesive will release if you carefully, and slowly, rotate the DI Module away from the clamp. It is not necessary to replace the adhesive when re-assembling the system.
9. Place the new Aquathin DI Module into the housing. Re-insert the tubing which connects the reservoir to the DI Module, taking care to attach the tubing to the outlet end of the module.
10. Replace the RO Module and clamps. Re-insert the blue tubing coming from the RO Module into the inlet end of the DI Module.
11. Re-insert the black tubing into the brine water discharge port on the RO Module.
12. Replace the retaining clips.

13. Replace the two wing-nuts which secure the RO/DI clamp.
14. Snap the two “Double C” clamps back onto the RO Module.
15. Place the new CARB 12 Pre-filter into the clamps, being sure the “FLOW” arrow points the same direction as noted in step 3 above.
16. Re-insert the feed water tube from the hose assembly into the inlet end of the CARB 12. Re-insert the tubing from the RO Module inlet into the outlet end of the CARB 12. Replace the retaining clips.
17. When all filters have been replaced and all tubes have been reconnected, hook the unit up to the faucet and turn on the water. Let the unit produce water for 10–15 minutes then drain the water, invert the unit, and inspect for leaks. If any water appears at any of the tubing connections, remove the retaining clip, remove and re-insert the tubing. Replace the retaining clip. (A leaking connection is extremely rare.)
18. You can now return the unit to service. Let the reservoir fill and discard the first tank of water (use it to water plants, etc.) You are now ready to again enjoy great tasting, pure Aquathin RO/DI water for another 12 months!

## FREQUENTLY ASKED QUESTIONS

**Q:** How long will my Aquathin CARB 12 pre-filter last before it needs to be replaced?

**A:** Under most normal city water conditions, the Aquathin Carb 12 is designed to function properly for 12 months, and should be replaced annually. Sediment concentrations vary greatly between municipal systems so there is no way of determining the lifetime of a filter without knowing more about the feed water. In some very rare cases, it may be necessary to replace the pre-filter more frequently.

**Q:** How long will my CARB 6 post-filter last before they need to be replaced?

**A:** Your Aquathin AQUALITE system has been designed to operate within a wide range of tap water conditions. These conditions vary greatly across municipalities, so it is difficult to state precisely how long your post-filter will last. We have designed the system so that under the most extreme conditions your post-filter will still be performing correctly after 12 months of use. The CARB 6 post-filter should be replaced when changing the RO module (once in 2-3 years). This will insure your system is consistently performing as designed, producing ultra-pure water that meets the standards for biocompatibility.

**Q:** How long will my reverse osmosis module last?

**A:** The module's life depends on the water conditions as listed in the specification section of this manual. If all these conditions are met, the life of the module is generally 2–4 years. If a module fails or its performance becomes reduced before this time, the cause can usually be traced to tap water conditions outside the specifications or failure to flush.

**Q:** How do I know if there is a problem with the module?

**A:** The best method is to measure the resistivity (conductivity) of the RO water and compare it to the tap water. You can invest in a reliable and inexpensive resistivity meter available from your Authorized Aquathin Dealer or you can send them samples for analysis. (Poor rejection rates may also be an indication of a clogged pre-filter, so check that filter first.) A large increase in the production rate is also an indication of module failure, and can often be traced to the module having been subjected to either freezing or hot water.

**Q:** How can I monitor the performance of the unit?

**A:** Your Authorized Aquathin Dealer will register your warranty card and purchase with Aquathin Corporation. Every year upon the anniversary of your installation, Aquathin Corporation and your Aquathin Dealer will mail or email an Annual Service Reminder to have your system inspected and serviced if necessary. Also, with identical feed water pressure, the production rate should remain fairly constant. If your system begins to produce water at a much faster rate, the RO module may have failed. If your system is producing water at a much lower rate, replacing the pre-filter is often indicated. To monitor the overall system rejection rate, the best method is to obtain either a resistivity meter or TDS meter from your Authorized Aquathin Dealer.

**Q:** Will I lose valuable minerals when I drink purified water?

**A:** No, the body does not readily assimilate the minerals found in drinking water. We obtain the majority of our minerals from the foods we eat. There are many more bio-available “chelated” minerals in a piece of organic fruit or a serving of organic vegetables than in several gallons of water.

**Q:** Will pure water leach minerals from my body?

**A:** This question reflects one of the common myths that are found in the water industry. It has no basis in fact or physiologic science. Pure water does perform a valuable function by helping the body eliminate wastes and unused minerals that have been excreted from cellular tissues, but it does not “leach” minerals out of the cells. This false claim was probably first made by companies wanting to boost sales of filters incapable of removing dissolved minerals and dangerous heavy metals. ASK your Authorized Aquathin Dealer for a copy of “5<sup>th</sup> Functions of Water”.

**Q:** Will hot water ruin my RO module?

**A:** YES! Hot water over 100° F will damage the module and void your warranty. Make sure you use only COLD water in your Aquathin system.

**Q:** How should I store my purified water?

**A:** Ask your Authorized Aquathin Dealer about clear Aquathin polycarbonate bottles.

**Q:** How should I store my unit when not in use?

**A:** If your unit is not used for several days, no special precautions are required. However, we do recommend you to flush the unit for 10-15 minutes and discard the first tank of water when you return the system to production. ...continued on next page...

**NOTE: SHOULD YOU LEAVE YOUR RESIDENCE FOR A FEW DAYS OR MORE, TURN OFF THE COLD WATER FEED LINE, UNPLUG THE ELECTRIC CORD, AND DRAIN THE TANK VIA THE CARAFE. REPEAT THE START UP PROCEDURE WHEN YOU RETURN.**

**Q:** How long does it take to make a tank of water?

**A:** The rate your system produces water is dependent upon several factors including source water pressure, temperature, and the amount of total dissolved solids (TDS). We rate our modules very conservatively, and the AQUALITE systems come with a up to 45 gallons of water per day module.

**Q:** When system enters flush mode, it makes noise. Is this normal?

**A:** When your system is flushing, water is flowing to the drain much faster than normal production mode. The check valve will sometimes chatter with the increased flow, and this can be heard as a hum or rattle. When your system is first put in service, there may be air in the lines that can also cause noise from the system. After a few days the noise typically will go away.

**Q:** How can I keep informed about Aquathin?

**A:** “Splash News Bulletin”, “Forum Q&A”, “Allergic Reaction”, “Biz Bank”, “Tech Bank”, and “Quote Bank” are all FREE services to all Authorized Aquathin Dealers and their Customers to keep you abreast of technology updates and industry news.

Email Aquathin at [info@aquathin.com](mailto:info@aquathin.com) to subscribe.

Visit [www.aquathin.com](http://www.aquathin.com).



## LIMITED WARRANTY

Aquathin Corporation warrants to the original owner of each AQUALITE water purification system to be free from defects in materials and workmanship for as long as you own the product.

### What The Warranty Covers

Full Lifetime Warranty on all parts (excluding normal module changes or abuse). 2 years on electronic components.

Your AQUALITE pure water appliance is a sophisticated water purification system. Failure to follow the maintenance schedule or use other-than genuine Aquathin components will void the exclusive lifetime warranty.

### Exceptions to Lifetime Warranty

The Lifetime Warranty does not include damage caused by or resulting from unreasonable use, including failure to provide reasonable maintenance, or incidental or consequential damages, such as water damage, mold or damage to appliances, fixtures or other equipment.

Warranty will be void if product failure or damage is due to any of the following:

1. Misuse, misapplication, neglect (e.g. inadequate fil-

ter changes), alteration, hot feed water, freezing, or accident.

2. Improper installation, operation, or servicing.
3. Use only Genuine Authorized Aquathin components to assure efficiency and to maintain your Warranty.
4. No one is authorized to change or add to this Warranty.

### **What We Will Do To Correct An Inconvenience**

Upon notice, we will repair or replace covered defective parts, free of charge. If it is necessary to return the product to an Aquathin Dealer for service, the buyer must pay for any shipping or travel costs. Aquathin Dealer will pay for any return shipping charges in the U.S. for parts or products covered under the Warranty.

An Aquathin Dealer will furnish any factory labor to make repairs on parts or products returned to the factory that are covered under the Warranty.

### **How State Law Relates To The Warranty**

Some states do not allow the exclusion or limitation of incidental or consequential damages, so the above limitation or exclusion may not apply to you. This warranty applies to the original purchaser and gives you specific legal rights. You may also have other rights which vary from state to state.

APPENDIX

A

## SPECIFICATIONS

Following are the recommended operating parameters for our custom rolled Reverse Osmosis Module:

Module type	Aquathin Spiral Wound Polyamide Thin Film Composite (TFC)
Production	Up to 45 Gallons-Per-Day (GPD)
Maximum Operating Temperature	40–100° F (4–38° C)
Operating Pressure	40–100 psi (2.75–6.9 bar)
pH Range	2.0–11.0
TDS Level, Maximum	2000 ppm
Turbidity	< 1.0 Net Turbidity (NTU)
Chlorine (Cl <sub>2</sub> )	0.00 mg/l *
Hardness (CaCO <sub>3</sub> )	< 427 mg/l
Iron (Fe)	< 3.0 mg/l
Manganese (Mn)	< 0.05 mg/l
Hydrogen Sulfide (H <sub>2</sub> S)	0.00 mg/l

\*Every system is equipped with our unique combination pre-filter to remove sediment and chlorine.

You can obtain specifics about your water supply from either your local water department or your local Authorized Aquathin Dealer. If the parameters of your water do not fall within the specified ranges as noted above, please contact your local Aquathin Dealer for further options. Production is rated at optimum temperature of 70° F, 60 PSI, and 500 ppm TDS. Actual production will vary depending on local temperature, pressure, and TDS level.

Low tap water pressure will reduce the volume and quality of the water produced by your system. In low pressure situations (<40 PSI) RO/DI values cannot be assured. The addition of a booster pump (PBA-G) is strongly recommended.

**ALWAYS USE COLD WATER**—hot water will damage the TFC membrane.

The unit must not be allowed to freeze. Freezing water will expand inside the modules—damaging the membrane and potentially rupturing the filter housings. Damage of this type will void the warranty.

This system has been tested and certified by IAPMO R&T according to NSF/ANSI 58 and WQA S-300 for reduction of TDS. The concentration of TDS in water entering the system was reduced to less than or equal to the permissible limit for water leaving the system, as specified in NSF/ANSI 58 and WQA S-300. Testing was performed under standard laboratory conditions. Follow installation procedures and scheduled maintenance for optimum performance.

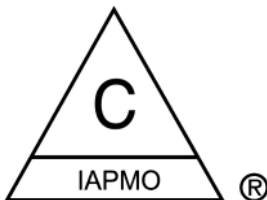

APPENDIX  
B

## REPLACEMENT SCHEDULE

Below you can find the recommended replacement schedule and part numbers for the components of your Aquathin water purification system.

### *Replacement Components*

<b>Module</b>	<b>Replacement Schedule</b>	<b>Order No.</b>
<b>Sediment &amp; GAC Pre-Filter</b>	Annually	CARB 12
<b>4-Stage Deionization Module</b>	Annually	ADI
<b>Aquathin Series RO Module</b>	2-3 Years (as needed)	HRO or XF-HRO
<b>GAC Post-Filter</b>	2-3 Years	CARB 6

Purchase Date: \_\_\_\_\_

Purchased From: \_\_\_\_\_

Serial/Model Number: \_\_\_\_\_

## Maintenance Log

Module Replaced	Date

### C1. Sink Mounted Faucet Assembly

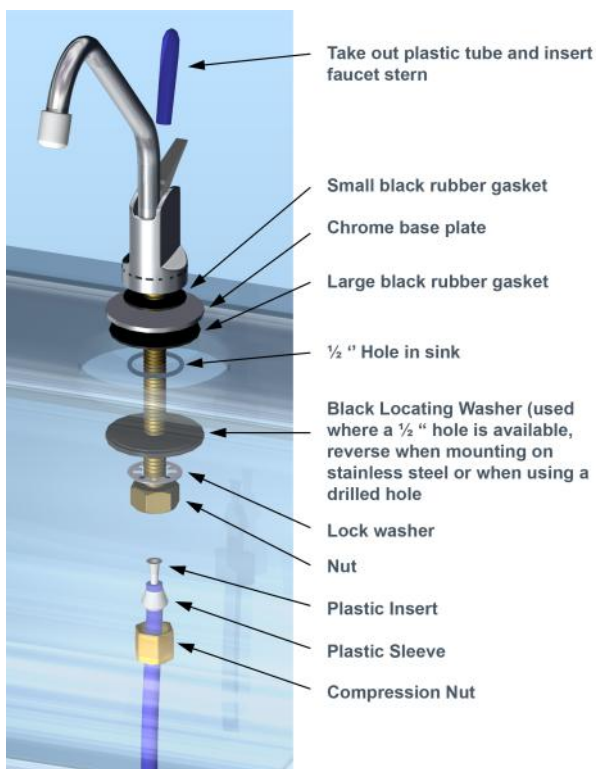

## C2. Anatomy of John Guest *Speedfit*® Fitting

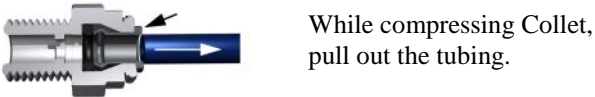
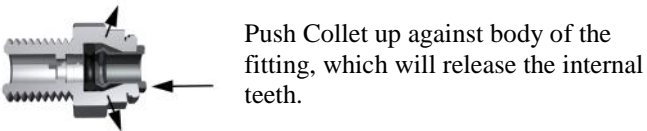
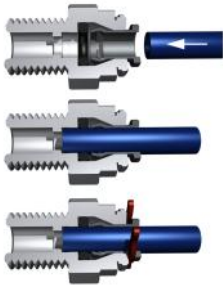
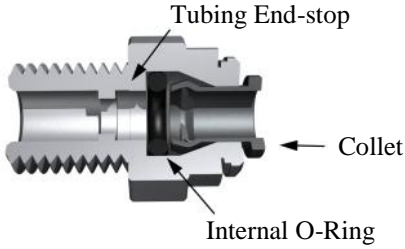



### C3. AQUALITE Installation Diagram

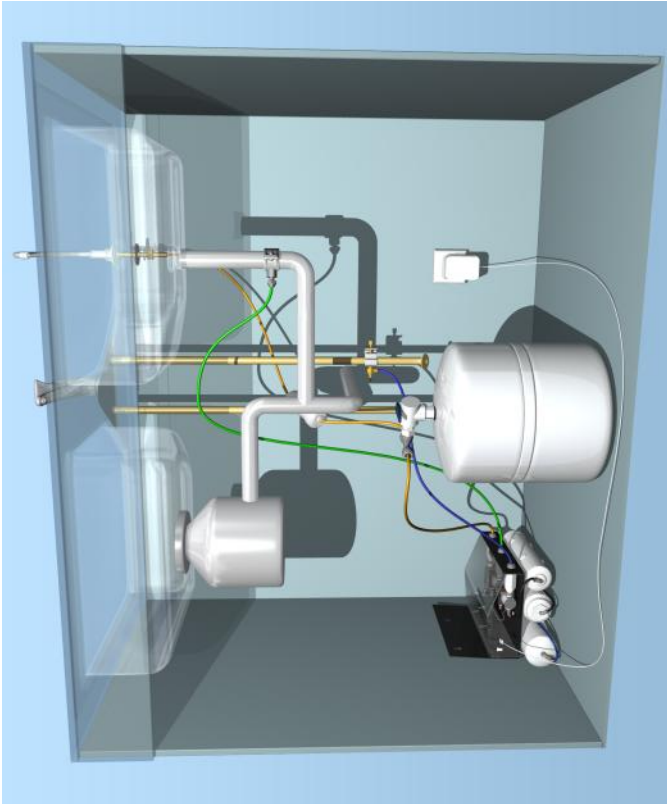

## C4. AQUALITE Installation Diagram (with optional pump)

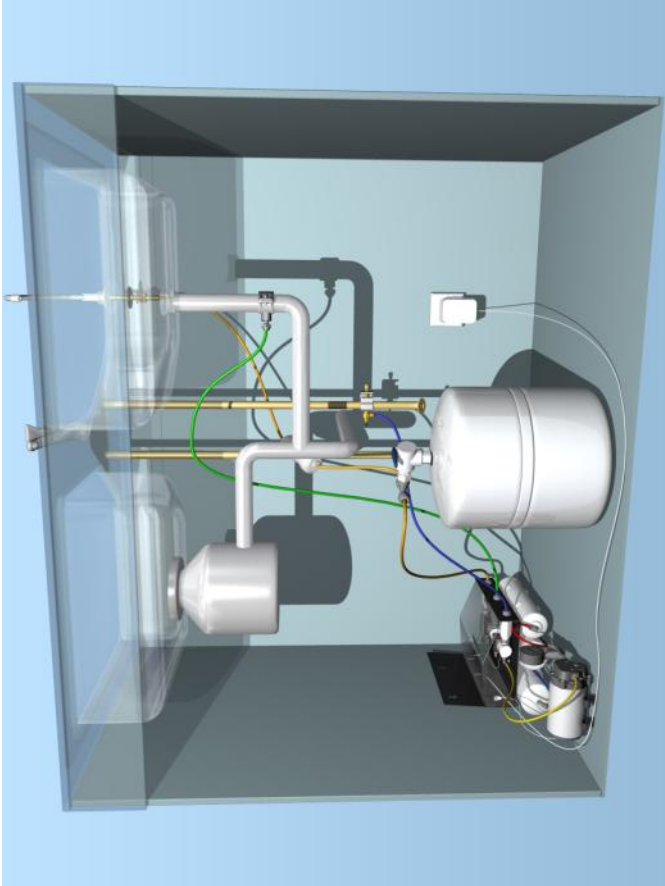

## C5. Schematics

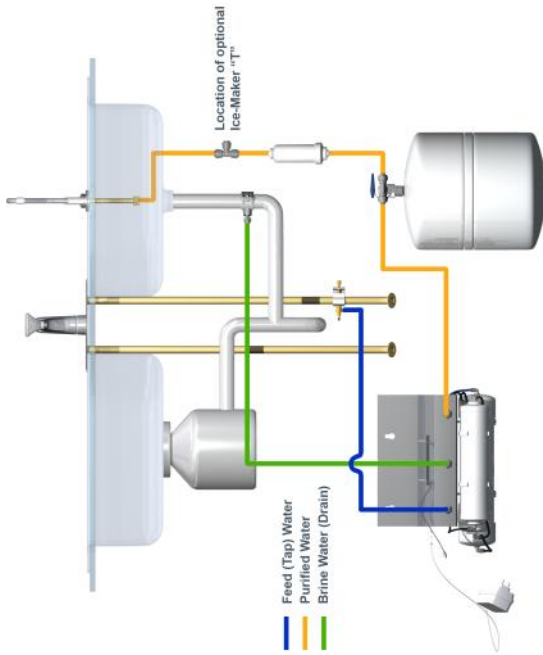

Purpose of diagram is to indicate tubing connection and location of components relative to water flow. Diagram is not drawn to scale and is not intended to indicate actual position of components beneath the sink.

## INSTALLING THE OPTIONAL PUMP

### 1. Prepare to Mount the Pump (PBA-G)

Identify a space to place the pump. The pump can be placed on the floor for convenience, preferably in close proximity to the main assembly. This will ensure that the tubing is kept to a minimum and is neatly arranged.

The pump may be mounted as well, however, do not mount the pump with screws until the tubing is completed.

In the main assembly, the CARB 12 pre-filter is connected to the feed assembly and to the RO Module, such that the flow is indicated coming from the feed water assembly to CARB 12 pre-filter to the RO Module. Remove the tubing that makes the connection between the feed assembly and the CARB 12 pre-filter; the pump will be connected in between these (figure D1).

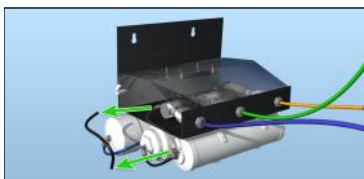

**Fig. D1: Remove tubing that connects CARB 12 to feed assembly**

## 2. Connect the Pump Inlet to the Feed Assembly

The Platinum Booster Assembly (PBA) includes both a pump and a pressure gauge. Remove the blue plugs on the pump by depressing the collets (figure D2).

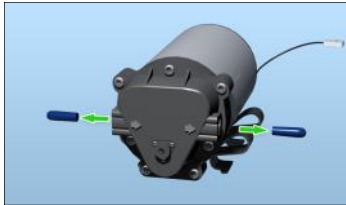

*Fig. D2: Remove the plugs*

Measure and cut a length of the **yellow** tubing to connect the pump to the feed assembly. Insert one end of the **yellow** tubing to the feed assembly **outlet** as shown in Figure D3 (where the CARB 12 pre-filter was previously connected).

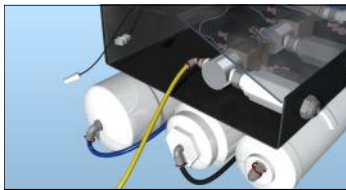

*Fig. D3: Connect yellow tubing to the feed assembly*

Insert the “T” connector of the pressure gauge in the pump **inlet** (Note the arrows indicating the flow). Refer to figure D4.



*Fig. D4: Connect pressure gauge to pump*

Insert the **yellow** tubing into the **other end** of the “T” connector. (Figure D5)

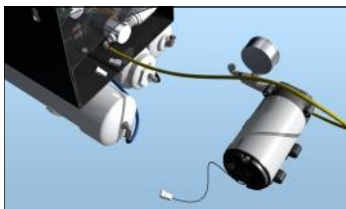
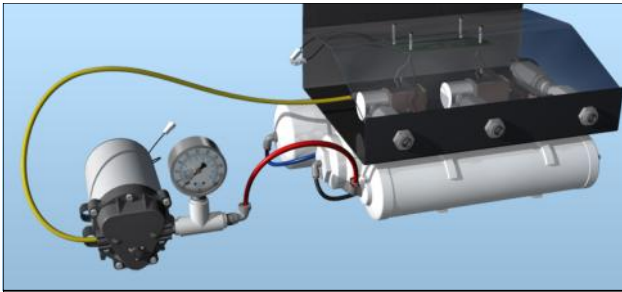

*Fig. D5: Insert yellow tubing from the feed assembly to pressure gauge*

### 3. Connect the Pump Outlet to the CARB 12 Pre-filter

Measure and cut a length of the **red** tubing to connect the pump to the CARB 12 pre-filter.

Insert one end of the **red** tubing into the pump outlet, and the other end of the tubing in the CARB 12 inlet. (Note the arrows indicating the flow on both the pump and the CARB 12 pre-filter).



*Fig. D6: Connect red tubing from pump outlet to CARB 12 inlet*

### 4. Mount the Pump (PBA)

Connect the pump to the pump jack on the main assembly (see [figure D7](#)).

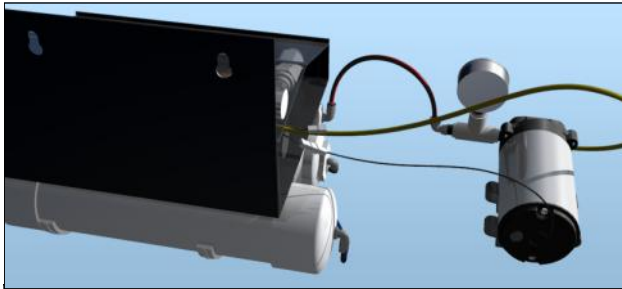

*Fig. D7: Connect pump to pump jack on main frame*

With the pump inlet, outlet and pump jack connected to the main assembly, the pump can now be mounted with screws in the position previously identified. (A pilot hole using a 1/16" drill bit is recommended for particle board side-walls.)

NOTE: you may rotate the face of the pressure gauge, if needed, for easier reading.



ISO 9001: 2008  
CERTIFIED



7 Patents Earned



8 Trademarks



Over 70 Systems



# 35 Years Pure Excellence

[www.aquathin.com](http://www.aquathin.com)



## aquathin USA

*Purifying the Waters of the World  
for the Best Taste in Life!*



EPA EST. NO. 52531-FL-01