



Getting Started With Your Aquathin Reverse Osmosis Water Treatment System

**Includes setup and maintenance information for:
Aquathin Commercial 100+24K, 600+24K and
1200+24K series**

**AN ISO 9001:2008 QMS
REGISTERED /CERTIFIED COMPANY
(IMS-0192 & NQA-12635)**

© 2007—2016 Aquathin Corporation. All rights reserved.

Under the copyright laws, this manual may not be copied, in whole or in part, without the written consent of Aquathin Corporation.

Every effort has been made to ensure that the information in this manual is accurate. Aquathin Corporation is not responsible for printing or clerical errors.

Aquathin Corporation

Aquathin Business Centre
950 South Andrews Avenue
Pompano Beach, Florida 33069
1-800-GO.2.RODI (462-7634) or 1-954-781-7777
Fax: 1-954-781-7336
Email: info@aquathin.com
www.aquathin.com

Aquathin Corporation, the Aquathin Corporation logo, Aquathin 100+/600+/1200+ 24K Series Water Treatment System are trademarks and copyright of Aquathin Corporation. Product specifications are subject to change without notice.

Your Authorized Aquathin Dealer Is:

Dealer Name _____
Contact _____
Address _____

Phone _____
Fax _____
Email _____

Introduction

Thank You for your purchase. Aquathin turned **"35 in 2015" to enjoy its Pearl Anniversary** and it's a great feeling of self satisfaction and accomplishment to be an Authorized Aquathin Dealer. You could not have picked a better time to consider the many benefits of becoming a member of the ever growing Aquathin Family. The Next Quarter Century Celebration Begins!

Aquathin has earned 7 Patents and manufactures a broad spectrum of unique and proprietary water purification, softening and filtration systems servicing the residential, commercial and laboratory markets. Established in 1980, Aquathin now produces over 70 proprietary and trademarked devices for markets around the world through more than 600 Authorized Aquathin Dealers. Aquathin is an E.P.A. Registered manufacturer, ISO 9001-2008 Certified and recipient of the prestigious President's Excellence Award in Export from the U.S. Commerce Department and the Nation's Blue Chip Enterprise Initiative Award from the U.S. Chamber of Commerce. We have a very impressive global client list that now includes you and your family. Recently we have launched a project, two years in the making, for Authorized Aquathin Dealers to provide total home air and water security...and more. Visit the Aquathin Allergy Store online at www.aquathin.com.

Aquathin does not sell franchises nor do we charge for territories. We want to make sure that our Dealers are service oriented and knowledge driven. We know that even though we make the best water treatment systems in the world, ultimately they are only as good as the people representing them. And this is why we make the very best water treatment Dealers in world. Your local Authorized Aquathin Dealer has received training and continuous education from Aquathin University. You can be assured that when you purchase from an Authorized Aquathin Dealer (or from the factory directly in areas where we have yet to approve and establish a Dealer) you are receiving the finest equipment and technical support this industry is able to offer. Highest quality water treatment systems and support good enough for my home...my family.

And that is my promise to you! I love my Aquathin!!

**FOR THE BEST TASTE IN LIFE &
35 Years Pure Excellence**

*...and another Quarter Century re-inventing the water industry!
Think Aquathin...AquathinK !!
(visit the **NEW** www.aquathin.com)*

"Alfie"

Alfred J. Lipshultz, President

P.S. Remember...the next best thing to owning an Aquathin is recommending one to a friend!

C o n t e n t s

1	Getting Started	7
	Setting Up Your System	8
	1. Unpack the System	9
	2. Required Tools	10
	3. Planning the Installation	10
	4. Installing the Chrome Faucet Assembly	10
	5. Installing the Feed Water Saddle Valve	11
	6. Installing the Drain Saddle Valve	12
	7. Preparing to Mount the Main Assembly	13
	8. Making the Tubing Connections	13
	9. Connecting Tubing to Speedfit® Fittings	14
	10. Connect Cold Water Supply Line	14
	11. Connect the Drain Line	15
	12. Mount the Main Assembly	15
	13. Prepare Storage Tank	15
	14. Connect Main Assembly to Storage Tank	16
	15. Connect GAC Post Filter	16
	16. Optional Connection to Dispensing Sites	17
	17. Optional Pure Water Blanket (PWB)	17
	Verify the Tubing and the Flow	17
	Starting Your System	18
	Indicators of System Activity	20
	Operation Procedure	20
2	Getting to Know Your RO System	23
	A Look at the Key Components	23
	Aquathin 100+ SED Pre-filter	23
	Granular Activated Carbon	24
	Aquathin Reverse Osmosis Module	24
	Operating Parameters	25
	Pressure	25
	pH	26
	Chlorine and Chloramines	26
	Sediment	26
	Iron	27

	Hardness and More	27
3	Maintenance And Servicing	30
	Exterior Cleaning	30
	Flushing	30
	Filter Replacement	31
4	Frequently Asked Questions	38
5	Limited Warranty	42
	What The Warranty Covers	42
	Exceptions To Warranty	42
	What We Will Do To Correct An Inconvenience	43
	How State Law Relates To The Warranty	43
A	ppendix A - Specifications	44
A	ppendix B - Replacement Schedule	46
	Replacement Components	46
	Maintenance Log	47
A	ppendix C - Connections	48
	C1—Sink Mounted Faucet Assembly	48
	C2—John Guest Speedfit® Fitting	49
	C3—Installation Diagram	50
	C4—Installation (with Pure Water Blanket)	51
A	ppendix D - Optional Installations	52
	D1—Pure Water Blanket Installation	52
	D2—Lab Dispensing Installation	54
A	ppendix E - Charts	55
	E1—Storage Tank Specifications	55
	E2—TDS vs. Flow	56
	E3—Temperature Correction Factor	57



CHAPTER
1

GETTING STARTED

Thank you for purchasing this quality water treatment system by Aquathin Corporation. The Aquathin 100+ 24K, 600+ 24K and 1200+ 24K Series Reverse Osmosis Water Treatment System follows the same pride, integrity and unique design, inherent to all Aquathin RO products. This small, compact lightweight RO unit packs the production capabilities of the larger more bulky units. The Aquathin 100+ 24K, 600+ 24K and 1200+ 24K Series can provide in excess of 200-1200 gallons of water per day. These systems can be used in bakeries, laboratories, restaurants, bottling, humidifiers, autoclave, carwash, high pressure cutters, cosmetics, grocery and product sprayers, pharmaceuticals and anywhere large volumes of purified water are required. Every Aquathin Series system combines several efficient methods of water treatment to achieve a very specific result—pure water that meets the rigorous standards for a host of industries. This user’s manual serves for the installation of the Aquathin 100+ 24K, 600+ 24K and 1200+ 24K models.

As the new owner of an Aquathin Commercial RO water treatment system there is a totally new experience awaiting you.

This manual provides information about the application and servicing of your Aquathin water treatment system. Descriptions of the components and their functions will help to answer frequently asked questions. By thoroughly reading this manual you will be better able to operate your new system and perform simple maintenance.

SETTING UP YOUR SYSTEM

Your Aquathin system requires adequate water pressure. The system operates at 110v/50Hz or 220v/60Hz, for obtaining a 24 volt controller efficiency. This unit is designed to operate within a pressure range of 30–230 PSI. The amount of purified water produced depends primarily on your water pressure, temperature, and the amount of Total Dissolved Solids (TDS), **refer to charts in Appendix E**. If you plan to install this unit on a private well system, you should check your water pressure gauge. If the low pressure setting is less than 40 PSI, ask a plumber to adjust and raise the pressure to the minimum level of 40 PSI. The unit is equipped with a Pump Guard which protects the pump from damage by shutting the unit down when feed water has ceased. Installation to comply with state and local laws and regulations.

Every 100+/1200+ unit includes the Aquathin Pump Guard and is wired to accept the New Pure Water Blanket (PWB) feature. The optional PWB will extend the life of the membranes by backwashing purified water over the membranes when the unit is dormant. Thus, the PWB eliminates concentrated feed water from the vessels.

Installing Your System Requires the Following Steps:

- ◆ Install the sink-mounted chrome faucet (optional).
- ◆ Install the feed water saddle valve to deliver tap water to your system.

- ◆ Mount the Frame Assembly to the cabinet sidewall (optional).
- ◆ Make the tubing connections.
- ◆ Install the Pure Water Blanket (PWB) to prolong the life of your unit (optional).

1. Unpack the System

Contents include:

1. Main RO assembly with frame, including RO modules, sediment pre-filter, pump, pump guard, and two gauges
2. Faucet assembly (optional)
3. Storage tank (optional—[see table on page 55](#))
4. Tank ball valve (optional)
5. Feed water saddle valve (optional)
6. Drain saddle valve (optional)
7. GAC pre-filter (optional)
8. Ice maker tee (optional)
9. Tubing (optional)
10. Pure Water Blanket (optional)
11. Pre-softening (optional)
12. LDI (Lab Deionization Modules) or DIX (DI exchange tank) - optional

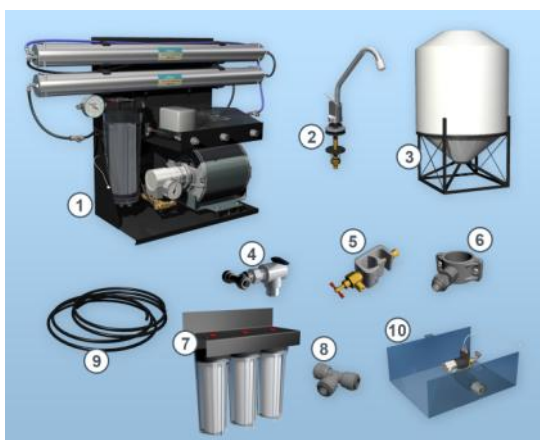

Figure 1. Package Contents

2. Required Tools

Hi Speed Drill	#2 Phillips Screw Driver
¼" High Speed Drill Bit	Teflon thread tape
½" High Speed Drill Bit	Razor knife with fresh sharp blade
⅓" High Speed Drill Bit	Adjustable Wrench
For porcelain sinks, a Dremmel® tool and ¾" silicon carbide grinding wheel or a Glass & Tile carbide spade-tipped bit.	For granite counter-tops, you will need to have a professional drill a ½" hole.

3. Planning the Installation

Review the following instructions completely before proceeding. (See [installation diagram on page 50](#).) Aquathin Commercial RO systems are comprised of several compact components which fit easily in most locations. **Install in a clean and dry environment with an ambient temperature range of 50°F to 95°F (10°C to 35°C).** We encourage you to establish the desired location of each of the components before proceeding. The optional storage tank has built-in feet for upright positioning and it can be placed on its side when space is limited. (A stand is included.)

4. Installing the Chrome Faucet Assembly

- 1) Select a location for the faucet on the sink top.

NOTE: Make sure there are no reinforcing ribs under the sink drilling location.



Figure 2. Pure water faucet on sink

2) Use factory approved method or approved plumbing practice to drill a 7/8" hole in the sink.

Porcelain sinks: factory approved method is: first grind away porcelain with a Dremmel® tool and silicon grinding wheel (about 3/4" circle). Then, use a standard 1/2"

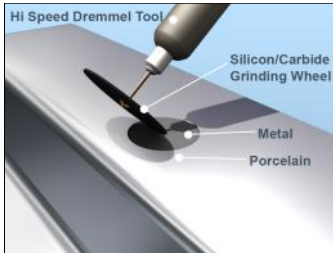

Figure 3. Use a Dremmel Tool to remove porcelain

high-speed drill bit to drill hole through metal portion of sink. (insert figures) Alternately, use a “glass and tile carbide spade tipped bit.”

Acrylic sinks: use 1/2" high-speed drill bit.

Stainless Steel sinks: use 1/2" high-speed drill bit or 1/2" Greenlee chassis punch.

3) Install faucet according to detailed diagram in [Appendix C1, page 48](#), insuring rubber gaskets are in place.

4) Tighten lock nut beneath sink. Save compression fitting parts for connection to GAC post-filter.

5. Installing the Feed Water Saddle Valve

The saddle-type valve supplied is intended for use on 3/8" to 1/2" copper tubing cold water supply line. It is not intended for flex lines.

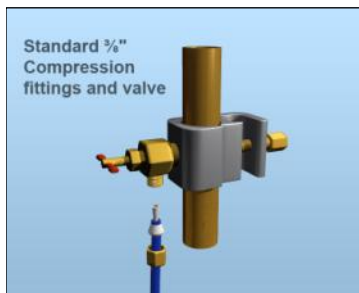

Figure 4. Feed water saddle valve.

Install on cold water line only!

NOTE: Color coding of tubing is for installation purposes.

Turn off the cold water valve under the sink or the main valve for the house. Slide clamp over the copper tubing and tighten screw firmly to hold the clamp in position. Pierce the copper tubing by turning the needle valve handle clockwise until it is firmly seated. The valve is closed in this position. Turn on the MAIN supply valve to pressurize cold water line. Immediately check for any signs of leaks. Set aside compression fittings for later use in connecting feed tubing to system.

When ready to supply water to the system, turn valve handle counter-clockwise until fully open. In some instances the self-piercing valve provided will not be compatible with your plumbing. We have provided a feed valve that will satisfy most scenarios. Alternate parts using standard $\frac{3}{8}$ " compression fittings can be found at a plumbing supply or at home improvement stores. On rare occasions, it may be necessary to contact a plumbing contractor to complete your installation.

6. Installing the Drain Saddle Valve

The drain saddle assembly should be installed above the trap and on the vertical or horizontal tailpiece. (See Figure 5). Refer to Figure 6 (next page) and

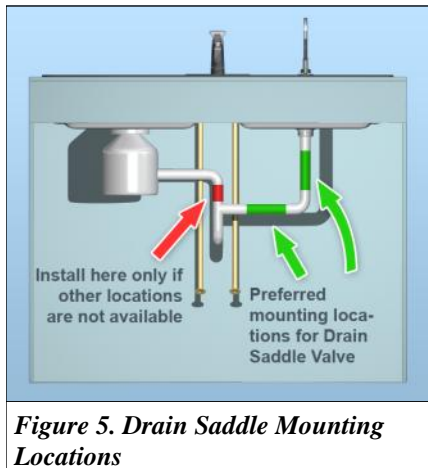

follow steps 1 through 4 to mount the drain saddle valve.

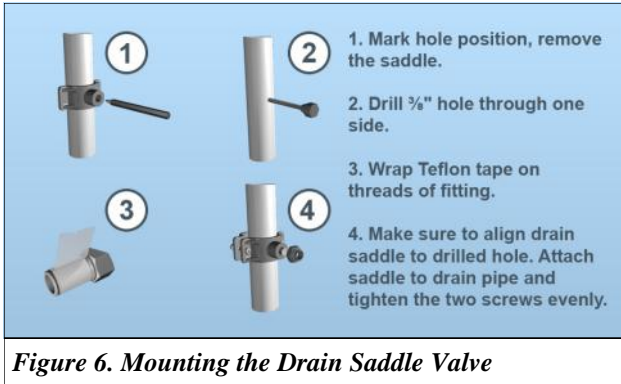

7. Preparing to Mount the Main Assembly

When possible we recommend mounting the main assembly, but *this is not a requirement*. Install the screws allowing for the thickness of the frame.

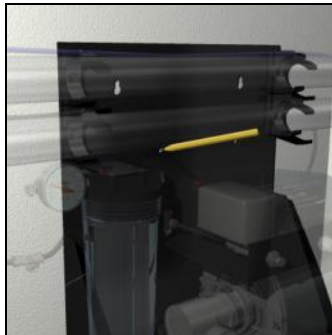

Figure 7. Mark the keyholes on the desired location prior to mounting the equipment

8. Making the Tubing Connections

You have completed the bulk of the installation tasks. All that remains is connecting tubing between the components.

The tubing is to be used to:

- Connect the feed water saddle valve to the inlet on the main assembly (indicated by connector to the left of housing next to gauge)
- Connect the chrome faucet to the inlet on the main assembly frame (indicated by “TO DRAIN”)
- Connect the tank to the inlet on the main assembly (indicated by “TO TANK”) and as well to connect the tank to the faucet .

NOTE: It is important to correctly measure the required length of the tubing for each connection prior to cutting the tubing. Additional tubing is required if you opted for the Pure Water Blanket (PWB).

9. Connecting Tubing to John Guest *Speedfit*® Fittings

Aquathin systems make extensive use of John Guest *Speedfit*® fittings. These high quality components provide secure, leak free seals and make it easy to connect and disconnect tubing without the use of tools. Refer to [diagrams on page 49, Appendix C2](#).

10. Connect Cold Water Supply Line

Measure and cut a length of tubing to connect the feed water saddle valve to the left inlet on the frame assembly.

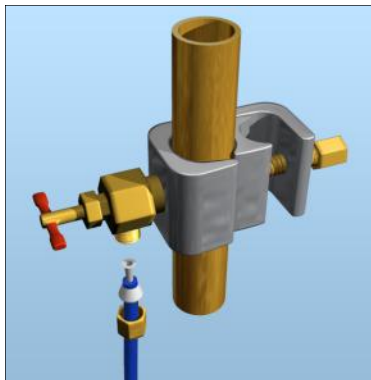
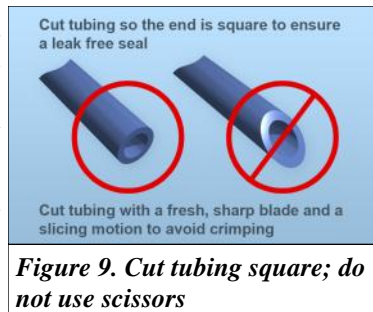

Figure 8. Connect 3/8" valve and tubing as shown (color coding of tubing is for installation purposes)

Connect the tubing to the saddle valve using the compression fittings provided. (See [figure 8](#) and [installation diagram on page 50](#).)

Cut tubing so the end is square to ensure a leak free seal. Cut tubing with a fresh, sharp blade and a slicing motion to avoid crimping. See [figure 9](#). (Use larger ball valve for higher flow).



11. Connect the Drain Line

Measure and cut a length of tubing to connect the drain water check valve (indicated by “TO DRAIN” on the frame assembly) to the drain water saddle valve.

IMPORTANT: Be sure to measure the tubing appropriately before cutting.

12. Mount the Main Assembly

With the cold water supply and drain line connected, the main assembly can now be placed onto the screws previously installed. Place the keyhole openings over the screws then slide the frame horizontally onto the mounting screws. You may wish to remove the main assembly and adjust the screws to make the connection as secure as possible.

13. Prepare Storage Tank

Remove the plug on the storage tank, revealing an inlet. Wrap Teflon pipe tape on the threads of the storage tank

inlet; then place three (3) drops of regular household chlorine bleach into the opening. Attach the tank ball valve as shown in figure 10. Close valve to prevent chlorine from escaping.

Close the tank ball valve by turning the blue handle perpendicular to the valve body;

then screw the valve onto the storage tank until firm. DO NOT OVER-TIGHTEN. Determine the position for the storage tank beneath the sink. If space is at a premium, it is OK to lay the tank on its side. A stand is included.

Wrap pipe tape on threads. Follow label instructions to ensure disinfection before attaching tank ball valve. Close valve to prevent chlorine from escaping



Figure 10. Storage tank preparation

14. Connect Main Assembly to Storage Tank

With the tank in position, measure and cut a length of tubing to connect the inlet of the main assembly indicated by “TO TANK” and the “T” connector on the tank ball valve. (See figure 11.)

15. Connect LDI Post Filter

Refer again to the installation diagram on page 50 in Appendix C3. The LDI post-filter is easily supported by the tubing and Speedfit®

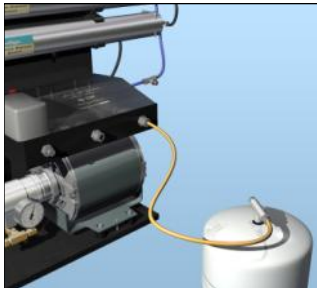

Figure 11. Main assembly to storage tank (color of tubing is for illustrative purposes)

fittings. Refer to the “Typical Lab Installations Diagram” in Appendix D2, page 54.

16. Optional connection to Multiple Dispensing Sites

Before connecting the post-filter to the faucet assembly (as described above), connect the post-filter to your ice maker, dispensing site, or wet bar etc using the Tee provided. (See figure 12.)

17. Optional Pure Water Blanket (PWB)

In order to extend the lifetime of your Aquathin 100+/1200+ unit, you may opt for the Pure Water

Blanket feature. The Pure Water Blanket (PWB) is designed to flush purified water over the RO membranes, when the unit is dormant. Thus, extending the life of the membranes by eliminating the concentrated feed water from the RO membranes. To setup and install this optional feature, refer to [instructions in Appendix D1](#).

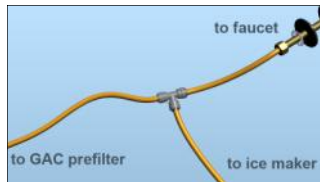

Figure 12. Connect the Ice Maker as shown (color of tubing is for illustrative purposes)

VERIFY THE TUBING AND THE FLOW

The water flow through the system can be verified to ensure that the tubing is done correctly.

Cold water enters the main assembly through the sediment pre-filter.

The purified water passes through the LDI post-filter and the tank before reaching the chrome faucet.

With PWB:

When the system is dormant, the treated water in the storage tank flushes through the PWB solenoid assembly to the tee at the feed water line and re-enters the unit. The flow then continues as above.

STARTING YOUR SYSTEM

1. Open the chrome faucet on the sink top.
2. Verify the Tank Ball Valve is open.
3. Slowly open your cold water supply valve.
4. Press the red button on top of your pre-filter and observe the pre-filter filling up with water; **see figure 13**.
5. Plug the unit into a power socket.

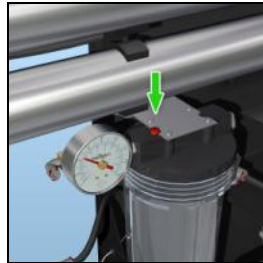

Figure 13. Press red button on filter

6. The inlet gauge near the pre-filter, with the red needle, is the **min gauge**. Manually rotate the dial in the center of the **min gauge** such that the red needle shows a lower PSI reading than the black needle.



Figure 14. Move red needle to the back side of the black needle

(For instance: If the black needle is pointing to 90 PSI, then move the red needle manually to 89 PSI). **See figure 14.**

7. Press the reset button on the IQ-EMP panel. **See figure 15.**

Your 100+/1200+ water treatment system is now in operation.

The unit will initiate the flush sequence for 2.0 minutes. During this time, the pressure gauge will read 30-60 PSI. After the flush procedure is completed, the pressure gauge will read 175-230 PSI while in normal production.

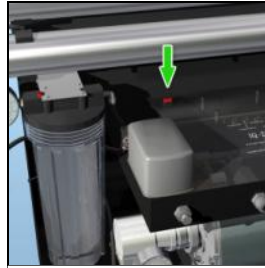

Figure 15. Press reset button on main panel

NOTE: The 100+/1200+ series is equipped with a “low pressure cut out” mechanism in the event the pre-filter is clogged or if source water diminishes. The pressure gauge next to the filter (the *min gauge*) will show you the lowest water pressure since the installation of the unit.



Figure 16. Red needle on min gauge shows the lowest PSI level

IMPORTANT: Monitor your system and check for leaks frequently over the first week.

Most leaks are attributed to tubing not fully seated inside the Speedfit® fittings. Remove the red lock clip, compress the collet, and remove the tubing. Re-insert the tubing until you feel it bottom out on the tubing end-stop. Replace the red lock clip. This process solves 99% of leaking connections. If the leak persists, trim ¼" – ½" off the end of the tubing and try again.

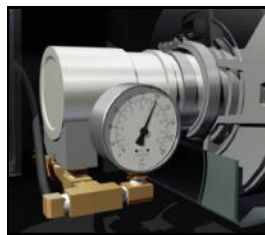

Figure 17. Black needle on pressure gauge showing PSI while system is in service or in flush mode.

Congratulations! You have completed the installation of your Aquathin water purification system. You are now ready to begin producing pure, Aquathin quality water.

INDICATORS OF SYSTEM ACTIVITY

The main system has four light indicators on the frame. These are important indicators of the system activity.

The **first green light** (from left) indicates that the power is turned on. This light appears when the system is running, filling, or flushing. It remains lit even when the tank is full and when the pressure is low.

The **second green light** (from left) turns on only when the tank is full. Therefore, when the tank is full, both the green lights will be lit.

The **first amber light** (from left) is lit when the system is active, i.e. when water is either filling or when the system is flushing. Therefore, if the tank is full and the system is idle this light will not be lit.

The **second amber light** (from the left) is lit only when the system is flushing; flushing is an automated function in the 100/1200+ series.









The **red light** indicates that the water pressure is low. If this light is turned on, you may need to use the optional pump system.

OPERATION PROCEDURE

Your Aquathin Auto Power Panel Subsink Reverse Osmosis Water Treatment System is self operational. The exclusive patented Aquathin IQ-SMP Selectronic Memory Panel does all the work! Each time the tank calls

for water, the system will self flush the RO Modules for 2.0 minutes and then manufacture water. Unlike other RO systems, this unique design helps to preserve the longevity of your RO Module by removing potentially plaquing debris. To further ensure the longevity of your system's lifetime, you may opt for the Pure Water Blanket feature (installation of the PWB detailed in [Appendix D1](#)).

NOTE: Should you leave your facility for a few days or more, turn off the cold water feed line, unplug the electric cord, and drain the tank via the faucet. Repeat the start up procedure when you return. *This will not be necessary if you opted for the Pure Water Blanket (PWB).*

	Green (power on)	Green (storage tank full)	Amber (system on/off)	Amber (system flushing)	Red (low feed pressure)
System running					
System flushing					
Tank full					
Low water pressure					



CHAPTER

2

GETTING TO KNOW YOUR AQUATHIN COMMERCIAL RO SYSTEM

Your Aquathin 100+/1200+ Water Treatment System combines the most effective water purification technologies available. Alone, each of these methods is highly effective for a particular group of pollutants—but only when combined can you be assured of complete removal of all contaminants. Every system combines Carbon Adsorption, Reverse Osmosis and (optional) Deionization. By carefully matching the components utilizing these methods, we are able to assure your system produces water which meets or exceeds the standards for industry and purity.

A LOOK AT THE KEY COMPONENTS

Aquathin 100+ SED Pre-filter

Water entering the system is first subjected to our spun-Polypropylene dual gradient (10-5 microns) sediment pre-filter. Any suspended particles such as sand, rust, or other deposits commonly found in the feed water supply are removed. This protects the Aquathin Reverse Osmosis Membrane from particles which might clog the

pores. This pre-filter has been carefully selected for its extremely high dirt holding capacity.

Granular Activated Carbon

Before water reaches the reverse osmosis module, it is subjected to a “Aquathin unidirectional” Granular Activated Carbon pre-filter. Flow is lengthwise, not radial, for maximum contact time and organic adsorption. Through the two-stage pre-filter we insure complete removal of organic contaminants including pesticides, herbicides, and other hydrocarbon based compounds.

A single gram of steam washed, bituminous grade, granular activated carbon typically has ≈1500 square meters of surface area—meaning our 2-stage 100+ GAC pre-filter provides over 200 acres (0.81 square kilometers) of surface area where organic contaminants dissolved in the water have an opportunity to be adsorbed and eliminated. This immense GAC surface area also insures complete and total conversion of chlorine and chloramines—protecting the Aquathin polyamide—thin film composite (TFC) Reverse Osmosis Module downstream.

Aquathin Reverse Osmosis Module

A custom designed and extremely efficient High Flow spiral wound Reverse Osmosis Module produces up to 200 to 1200 gallons of purified water per day. The Aquathin RO Module utilizes the unique properties of a semi-permeable material which allows passage of pure water molecules while not allowing dissolved salts, heavy metals, organics and disease causing water-borne microorganisms to pass through.

Our extraordinary module is designed to consistently and significantly reduce the total dissolved solids in the source water supply by greater than 98+%. It also has a tremendous capacity to completely reject organic and biological contaminates, including disease causing water-borne microorganisms. EPA EST. NO. 52531-FL-01

The Aquathin Reverse Osmosis Modules used in this system can tolerate significantly higher concentrations of oxidizing contaminants like iron and manganese than RO modules found in other systems, as well as a much higher degree of hardness. However, there are limitations—the operating parameters for this module are found in the Specifications section of this manual.

OPERATING PARAMETERS

To insure proper operation of your 100+/1200+ Water Treatment System, it is advisable to collect the following information about your water supply. This information is generally available from your municipal water department, and in many cases is available from the website of your local Department of Public Works.

Pressure

In order to overcome the natural osmotic force, adequate water pressure must be available from your water supply. The osmotic force is directly proportional to the concentration of dissolved solids in the water. When the water pressure is equal to the osmotic force, there will be no movement of pure water molecules across the semi-permeable reverse osmosis module. Aquathin Commercial RO re-pressurizes from 185 PSI to 230 PSI.

In general, the higher the pressure, the better the performance of the module at rejecting contaminants.

pH

The Aquathin HRO TFC module will hold up very well when the pH of the feed water is between 2 and 11. Water supplies with pH over 11 are very rarely, if ever, found. (Chlorine bleach has a pH of ~11.5.)

Chlorine and Chloramines

Chlorine is the most common substance added to municipal water supplies. Its purpose is to eliminate biological growth (i.e. chlorine is toxic). Regulations usually require there be residual chlorine when water reaches your tap. Typically, the residual concentrations of chlorine in household water range from 0.5 to 1.0 parts per million (ppm).

Besides being toxic, chlorine and chloramines will degrade the TFC Reverse Osmosis Module. Therefore, it is essential to remove chlorine from your feed water before it reaches the RO Module. Your Aquathin Commercial RO system recommends a pre-filter containing a special grade of grade of Granular Activated Carbon (GAC) which will very effectively remove chlorine and chloramines from your tap water. It is important to replace the pre-filter annually to insure no chlorine is reaching the membrane. (See option choices: T-PFP, Aquashield, Megachar Series).

Sediment

In areas with very high sediment concentrations the Aquathin pre-filter may clog prematurely. If the pre-filter becomes clogged, you will likely notice a decrease in the production rate from your system. If the water pressure falls below the minimum level, the Low-Pressure-Cut-Off mechanism will be activated to protect the pump from damage. In areas with very high sediment

concentrations, it may be necessary to replace the pre-filter on a semi-annual basis.

Over the course of one year, the sediment filter will typically become significantly discolored. This is not cause for alarm. If you notice pressure at the gauge has dropped significantly below your initial observations, consider changing this filter to restore adequate pressure and improve overall system performance.

Iron

Iron concentrations greater than 0.1 mg/l can degrade overall system performance. If your water supply has iron concentrations above 0.1 mg/l, pretreatment is recommended for RO systems.

Hardness and More

Two thirds of the water on earth is groundwater. As it travels through rock and soil it picks up particles of calcium, magnesium, iron, lead, and other minerals. For 85% of the country, that translates into “hard water”. “Hardness” refers to the amount of calcium and magnesium in the water and is measured in grains per gallon (gpg). The following guide defines your water’s hardness based on two different measurements. Our test determines the grains of hardness that can easily be converted into the ppm.

Most of the problems associated with hard water are economical in nature. Hardness causes unsightly soap scum on fixtures, water spots on glasses and whitish scale deposits in your tubs and showers. Hard water means you use more soap and cleaning agents because they first have to “clean” the water before they clean anything else.

Description	Grains of Hardness	Parts per Million	Laundry Detergent Required
Soft (ideal)	0.0—1.0	0—18	1/4 dispenser
Slightly Hard	1.0—3.5	18—60	1/4 dispenser
Moderately Hard	3.5—7.0	60—120	1/2 dispenser
Hard	7.0—10.5	120—180	1/2 dispenser
Very Hard	10.5— over	180— over	Full dispenser

Here is a little additional information about the ordinary RO systems:

1. They state their systems must be installed on water with less than 3 grains of hardness. Otherwise you need an expensive water softener just for the RO system. Your Aquathin can be installed on hard water up to 10 grains due to the patented flush.
2. There is a disclaimer that those units may not be installed on microbiologically unsafe water. But would that not be a reason one would purchase a system? Your Aquathin will remove disease causing waterborne microorganisms.
3. Their warranty is 90 days, but may not cover the RO module, yet that is the heart of the unit. When service is needed, you must ship the system out of town. Some require the module to be replaced every

6 months according to them. Your Aquathin carries a Full 1 Year Warranty except for normal filter changes and abuse.

You originally invested in your Aquathin to provide your business the very best in water security. There is hardly anything in this world that a man could not make a little worse or a little cheaper, and the people who consider price alone are this man's lawful prey. It's like this: we would rather explain price once than apologize for poor quality and service the rest of our life. In 1980 Aquathin made the decision at the onset; that we would never sacrifice or lower quality for price... too much depends on it. Would you prefer that your company choose a system whose poor technology and cheap design allows it to continue to pass contaminants... or a product that provides the safest and most pure water available?

I LOVE MY AQUATHIN!

MAINTENANCE AND SERVICING

Minimal work is required to keep your Aquathin system in peak operating condition. Simply replace the filter modules as recommended. These simple steps will insure your unit consistently produces ultra-pure water meeting Aquathin standards.

Take care of your Aquathin system and it will provide many years of healthy drinking and cooking water for your entire business.

1. Exterior Cleaning

The exterior surface of your Aquathin can be kept looking like new by occasionally cleaning the surfaces with a soft cloth. Great care was taken in the choice of material for your unit, but the cabinet cannot withstand harsh chemicals or solvents. Use a mild, non-abrasive dish washing detergent or diluted spray cleaner to remove smudges or food stains, then rinse and dry the surface. Use of abrasive scouring powders or glass cleaning products containing ammonia are not recommended.

2. Flushing

Flushing is the single most important maintenance function needed to keep your system operating at peak efficiency and it extends the service life of the reverse

osmosis module. This simple operation has been automated in the **Aquathin 100+/1200+ series**.

If your unit has not been used for more than one week, drain the storage tank, then flush as described above. This measure need not be taken if you opted for the **Pure Water Blanket** feature.

3. Filter Replacement

After 12 months of use, it is time to replace the Aquathin Sediment pre-filter to insure your system is producing water within RO parameters. After 2-3 years (depending on the level of contaminants in water), the Reverse Osmosis (RO) Modules should be replaced. Replacement modules can be ordered directly from your local Authorized Aquathin Dealer.

1. Turn off the cold water supply line.
2. Drain ALL the water from the storage tank by opening the sink mounted faucet.
3. Close the faucet and the ball valve on the top of the storage tank.
4. Place a towel beneath the pre-filter/RO assembly—it will absorb the small amount of water that will spill from the modules as they are changed out.

It is often helpful to have an empty 3-5 gallon bucket nearby.

Removing the Aquathin Modules

Before proceeding, refer to [Appendix C2 on page 49](#).

Remove the tubing connections to the Aquathin Modules – NOTE: refer to [figure 18](#) on how to release tubing and follow the procedure outlined:

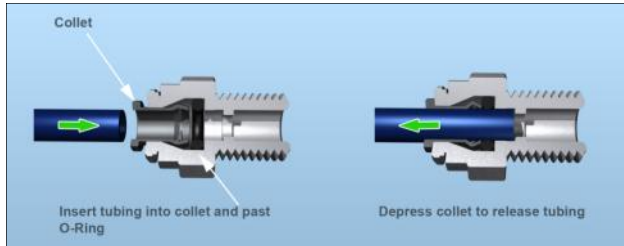

Figure 18: Speedfit Push-in Fittings

Replacing the Aquathin Sediment Pre-filter

The first filter you need to remove is the Aquathin 100+ SED pre-filter. The sediment pre-filter is in the canister on the left side of the assembly. The sediment pre-filter will likely be distasteful looking—it is common for sludge to form on the filter surface. After one year, this sludge layer can be fairly thick.

- a) Push the red button (on the top of the aluminum frame, above the pre-filter canister) to reduce any back pressure remaining in the canister.
- b) Firmly grasp the canister with both hands and unscrew it from the pre-filter assembly. (A canister wrench is available.) Carefully move the canister over the bucket, dump the water, and remove the old pre-filter.
- c) Using a long handled, soft bristle brush, scrub the inside of the canister with a mild dish washing detergent and rinse.
- d) Place the new pre-filter into the canister, and then carefully re-attach the canister to the assembly. Tighten until firm.

Replacing the RO Modules

The tubing is attached to the modules using a unique push-in fitting system. This system is designed to make connecting and disconnecting filter modules very easy

while insuring a water tight connection.

The “collet” assembly will securely hold the tubing in place under normal operating conditions. Pulling on the tubing will not cause it to release, instead the “grip” of the collet will become more secure. An O-ring behind the collet assures a leak free seal.

To insure your system will be water-tight even after being shipped across country, we have inserted small plastic retaining clips on each fitting. These are easily removed with your fingers or, if grabbing the clip is difficult, you may wish to use a pair of needle-nose pliers.

- a) Remove the retaining clips from each end of the Aquathin RO Modules, then remove the tubing itself. You will feel some resistance as the tubing slides away from the O-ring inside the fitting.

- b) With the RO Modules free of their connections, they can now be removed from the two “Single C” clamps holding them to the main frame of the assembly. *Note the direction of the “FLOW” arrow on the*

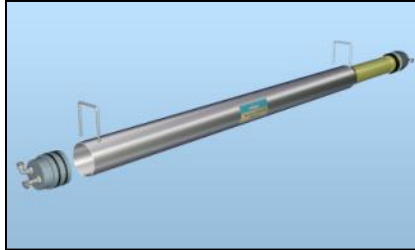

Figure 19: a) disconnect the tubing from both the RO Modules
b) Remove the RO Modules from the clamps holding them to the frame

You will need to install the new RO Modules in the same

orientation. Refer to **Figure 19.**

- c) A f t e r removing the RO Modules from the main frame, you must remove their outer chrome cover. Pull gently at the connector on one end of a RO Module, disconnecting it from the Module.



**Figure 20: a) remove the connector from one end
b) Drag the RO Module out of its casing through the other end**

- d) Gently remove the RO Module from the other end by pulling gently at the other connector. The RO module will thus be removed from its chrome casing. Repeat the same steps for the other RO Module.

Note the direction of the “FLOW” arrow on the pressure vessel and RO module. You will need to install the new RO Modules in the same orientation.

Reconnecting the RO Modules

Refer to **figure 21** in order to reconnect the tubing to the RO Modules.

- a) Replace one of the RO Modules on the lower double clamps. This RO Module must have an elbow shaped connector on one end and a swivel tee connector on the other end.
- b) Connect the feed line (originating from the feed water inlet and then through the pre-filter) with a



***Figure 21: i) Lower RO Module has an elbow connector on one end; on the other end there is a swivel tee connector and an elbow connector
ii) Upper RO Module has two swivel elbow connectors on one end and an elbow connector on the other end
iii) The labels on the RO Modules should face you***

black tube to the elbow connector on the left end of the RO Module.

- c) Connect the product line (originating from the tank outlet on the main frame) with a blue tube to the swivel tee connector on the right end of the RO Module.

- d) Replace the second RO Module on the upper double clamps. This RO Module must have two swivel elbow connectors on one end and an elbow connector on the other end.
- e) Connect the brine line (originating from the drain outlet on the main frame) with a black $\frac{3}{8}$ " tubing to the lower swivel elbow connector on the left end of the RO Module. (NOTE: In order to be able to determine which is the lower connector, the label on the RO Module stating "Aquathin Reverse Osmosis Module" must be upright and facing you).
- f) Connect a blue tube to the upper elbow on the left end of this RO Module to the swivel tee on the on the right end of the other RO Module.
- g) Finally, connect a black tube from elbow connector on the right end of the upper RO Module to the elbow connector on the right end of the lower RO Module.

Disinfecting the Storage Tank

- a) Disconnect the tubing from the "T" connector on the tank ball valve and remove the storage tank from beneath the sink.
- b) Wrap a towel around the ball valve and slowly unscrew the valve from the storage tank. There is always some water remaining in the tank and this will escape when the valve is removed. After setting the valve aside, place the towel over the tank opening and shake and rotate the tank to remove any remaining water.
- c) Re-wrap the threads with Teflon® pipe tape.
- d) Now place a few drops of liquid chlorine bleach into the top of the tank and re-install the tank ball valve (with the valve in the closed position).
- e) Reconnect the tubing to the swivel "T" connector.

Returning the system to service

- a. Open the valve on top of the storage tank.
- b. Slowly re-open the cold water supply line. Press the red button on the pre-filter, and the canister should begin to fill.
- c. Check for leaks around the tops of the pre-filter canister. If water is seeping from any of the canister turn the cold water supply off, and then relieve line pressure by pressing the red button on top of the canister. Unscrew the canister from the assembly. Check to be sure the O-ring is properly seated and then carefully re-attach the canister to the assembly, taking care to align the filter module inside. Tighten until firm.
- d. Check for leaks at either end of the RO modules and at the storage tank.
- e. Allow the system to produce a full tank of water.
- f. Drain off and discard the initial tank of water. Do not use for cooking or drinking.
- g. You are now ready to enjoy great tasting, pure Aquathin water for another 12 months!



CHAPTER
4

FREQUENTLY ASKED QUESTIONS

Q: How long will my Aquathin 100+ SED pre-filter last before it needs to be replaced?

A: Under most normal city water conditions, the Aquathin 100+ SED is designed to function properly for 12 months, and should be replaced annually. Sediment concentrations vary greatly between municipal systems so there is no way of determining the lifetime of a filter without knowing more about the feed water. In some very rare cases, it may be necessary to replace the pre-filter more frequently.

Q: How long will my Carbon pre-filter last before it needs to be replaced?

A: If there is a Carbon pre-filter, you need to check for chlorine levels quarterly and change your filter accordingly. Your Aquathin system has been designed to operate within a wide range of tap water conditions. These conditions vary greatly across municipalities, so it is difficult to state precisely how long your CARB pre-filter will last.

Q: How long will my reverse osmosis module last?

A: The module's life depends on the water conditions as listed in the specification section of this manual. If all these conditions are met, the life of the module is generally 2–4 years. If a module fails or its performance becomes reduced before this time, the cause can usually be traced to tap water conditions outside the specifications or failure to flush.

Q: How do I know if there is a problem with the module?

A: The best method is to measure the resistivity (conductivity) of the RO water and compare it to the tap water. You can invest in a reliable and inexpensive resistivity meter available from your Authorized Aquathin Dealer or you can send them samples for analysis. (Poor rejection rates may also be an indication of a clogged pre-filter, so check that filter first.) A large increase in the production rate is also an indication of module failure, and can often be traced to the module having been subjected to either freezing or hot water.

Q: How can I monitor the performance of the unit?

A: Your Authorized Aquathin Dealer will register your warranty card and purchase with Aquathin Corporation. Every year upon the anniversary of your installation, Aquathin Corporation and your Aquathin Dealer will mail or email an Annual Service Reminder to have your system inspected and serviced if necessary. Also, with identical feed water pressure, the production rate should remain fairly constant. If your system begins to produce water at a much faster rate, the RO module may have failed. If your system is producing water at a much lower rate, replacing the pre-filter is often indicated. To monitor the overall system rejection rate, the best method is to obtain either a resistivity meter or TDS meter from your Authorized Aquathin Dealer.

Q: Will I lose valuable minerals when I drink purified water?

A: No, the body does not readily assimilate the minerals found in drinking water. We obtain the majority of our minerals from the foods we eat. There are many more bio-available “chelated” minerals in a piece of organic fruit or a serving of organic vegetables than in several gallons of water.

Q: Will pure water leach minerals from my body?

A: This question reflects one of the common myths that are found in the water industry. It has no basis in fact or physiologic science. Pure water does perform a valuable function by helping the body eliminate wastes and unused minerals that have been excreted from cellular tissues, but it does not “leach” minerals out of the cells. This false claim was probably first made by companies wanting to boost sales of filters incapable of removing dissolved minerals and dangerous heavy metals. ASK your Authorized Aquathin Dealer for a copy of “5th Functions of Water”.

Q: Will hot water ruin my RO module?

A: YES! Hot water over 100° F will damage the module and void your warranty. Make sure you use only COLD water in your Aquathin system.

Q: How should I store my purified water?

A: Ask your Authorized Aquathin Dealer about clear Aquathin polycarbonate bottles.

Q: How should I store my unit when not in use?

A: If your unit is out of service for several days, no special precautions are required. However, we do recommend you to opt for the Pure Water Blanket, which ensures auto-flushing when the system is dormant,

thereby increasing its longevity.

NOTE: SHOULD YOU LEAVE YOUR RESIDENCE FOR A FEW DAYS OR MORE, TURN OFF THE COLD WATER FEED LINE, UNPLUG THE ELECTRIC CORD, AND DRAIN THE HOLDING TANK VIA THE CARAFE. REPEAT THE START UP PROCEDURE WHEN YOU RETURN.

Q: How can I stay informed about Aquathin?

A: “Splash News Bulletin”, “Forum Q&A”, “Allergic Reaction”, “Biz Bank”, “Tech Bank”, and “Quote Bank” are all FREE services to all Authorized Aquathin Dealers and their Customers to keep you abreast of technology updates and industry news.

Email Aquathin at info@aquathin.com to subscribe.

Visit www.aquathin.com.



CHAPTER
5

LIMITED WARRANTY

Aquathin Corporation warrants to the original owner of each Aquathin water purification system to be free from defects in materials and workmanship for as long as you own the product.

What The Warranty Covers

- 1) One Year Warranty on electronic parts, RO Membranes, end plug, o-rings and clamps.
- 2) Five Year Warranty on the pressure vessels
- 3) Lifetime Warranty on the main frame.

Your Aquathin pure water appliance is a sophisticated water treatment system. Failure to follow the maintenance schedule or use other-than genuine Aquathin components will void the exclusive Warranty.

Exceptions to the Warranty

The Warranty does not include damage caused by or resulting from unreasonable use, including failure to provide reasonable maintenance, or incidental or consequential damages, such as water damage, mold or damage to appliances, fixtures or other equipment.

Warranty will be void if product failure or damage is due to any of the following:

1. Misuse, misapplication, neglect (e.g. inadequate filter changes), alteration, hot feed water, freezing, or accident.
2. Improper installation, operation, or servicing.
3. Use only Genuine Authorized Aquathin components to assure efficiency and to maintain your Warranty.
4. No one is authorized to change or add to this Warranty.

What We Will Do To Correct An Inconvenience

Upon notice, we will repair or replace covered defective parts, free of charge. If it is necessary to return the product to an Aquathin Dealer for service, the buyer must pay for any shipping or travel costs. Aquathin Dealer will pay for any return shipping charges in the U.S. for parts or products covered under the Warranty.

An Aquathin Dealer will furnish any factory labor to make repairs on parts or products returned to the factory that are covered under the Warranty.

How State Law Relates To The Warranty

Some states do not allow the exclusion or limitation of incidental or consequential damages, so the above limitation or exclusion may not apply to you. This Warranty applies to the original purchaser and gives you specific legal rights. You may also have other rights which vary from state to state.



APPENDIX

A

SPECIFICATIONS

Following are the recommended operating parameters for our custom rolled Reverse Osmosis Module:

Module type	Aquathin Spiral Wound Polyamide Thin Film Composite (TFC)
Production	Up to 600 Gallons-Per-Day (GPD)
Maximum Operating Temperature	40–100° F (4–38° C)
Operating Pressure	30–230 psi
pH Range	2.0–11.0
TDS Level, Maximum	2000 ppm
Turbidity	< 1.0 Net Turbidity (NTU)
Chlorine (Cl ₂)	0.00 mg/l *
Hardness (CaCO ₃)	< 171 mg/l
Iron (Fe)	< 0.10 mg/l
Manganese (Mn)	< 0.05 mg/l
Hydrogen Sulfide (H ₂ S)	0.00 mg/l

*Every system is equipped with our unique combination pre-filter to remove sediment and chlorine.

You can obtain specifics about your water supply from either your local water department or your local Authorized Aquathin Dealer. If the parameters of your water do not fall within the specified ranges as noted above, please contact your local Aquathin Dealer for further options. Production is rated at optimum temperature of 70° F, 60 PSI, and 500 ppm TDS. Actual production will vary depending on local temperature, pressure, and TDS level.

ALWAYS USE COLD WATER—hot water will damage the TFC membrane.

The unit must not be allowed to freeze. Freezing water will expand inside the modules—damaging the membrane and potentially rupturing the filter housings. Damage of this type will void the warranty.

This system has been tested and certified by IAPMO R&T according to NSF/ANSI 58 and WQA S-300 for reduction of TDS and has been verified and substantiated by test data. Testing was performed under standard laboratory conditions. Follow installation procedures and scheduled maintenance for optimum performance.

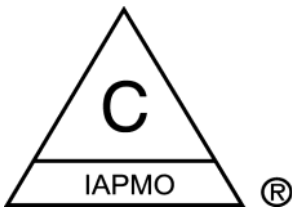

APPENDIX
B

REPLACEMENT SCHEDULE

Below you can find the recommended replacement schedule and part numbers for the components of your Aquathin water purification system.

Replacement Components

Module	Replacement Schedule	Order No.
Sediment Pre-filter	Annually	100+ SED
GAC Pre-Filter	Inspect Quarterly	100+ GAC, Aquashield, Megachar
Aquathin Series RO Module	2-3 Years (as needed)	HRO 25 for 100+24K or HRO 2540 for 600+ and 1200+ 24K

Purchase Date: _____

Purchased From: _____

Serial/Model Number: _____

Maintenance Log

Module Replaced	Date

C1. Sink Mounted Faucet Assembly

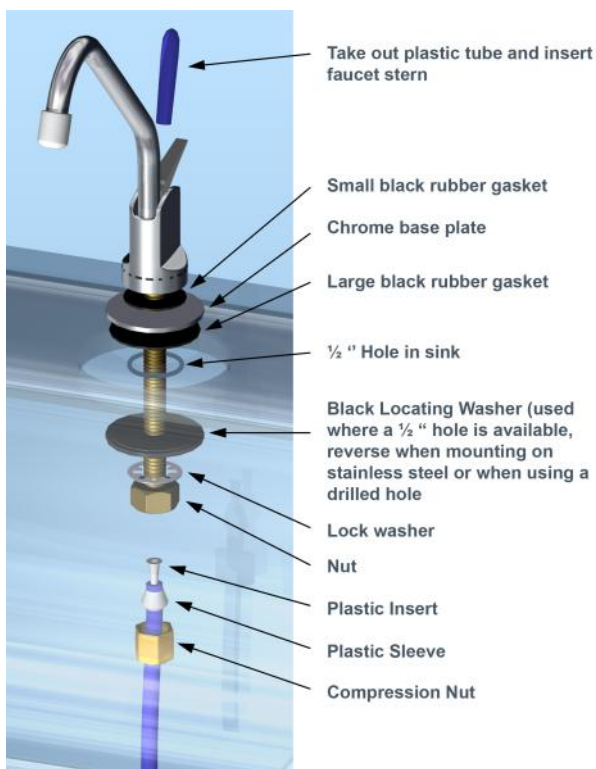

C2. Anatomy of John Guest *Speedfit*® Fitting

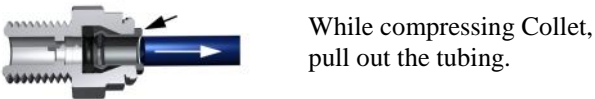
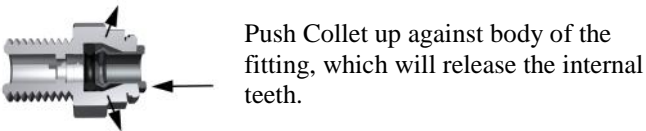
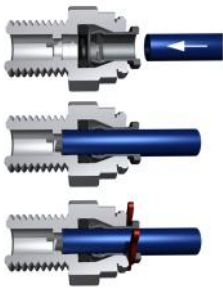
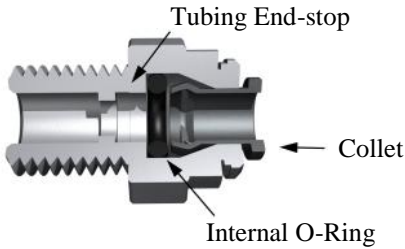

C3. Installation Diagram

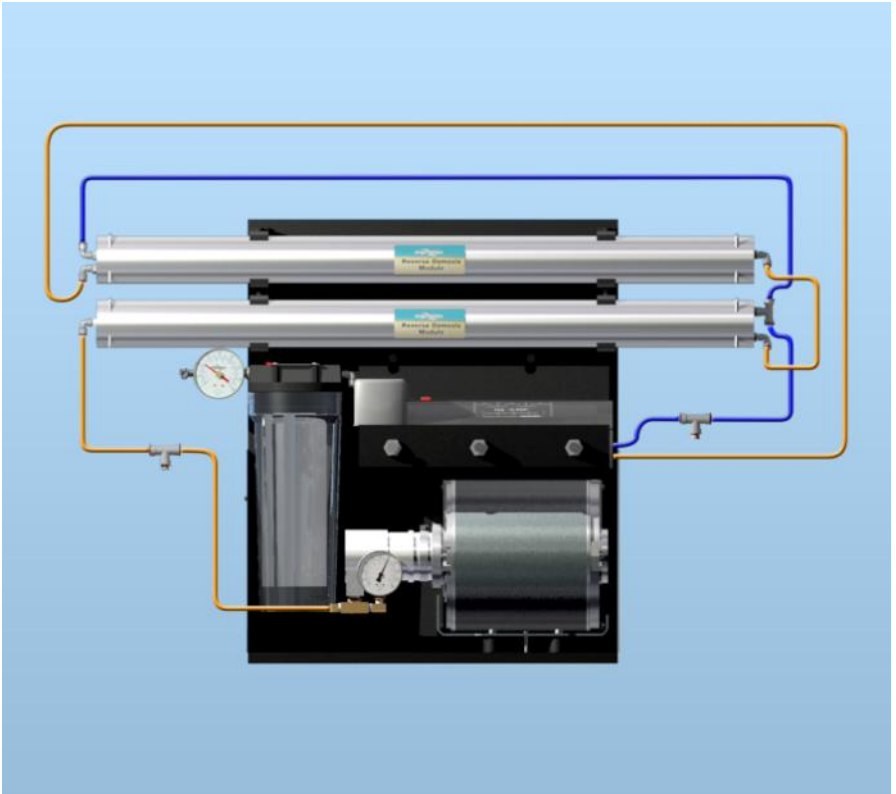

C4. Installation Diagram (with optional Pure Water Blanket)

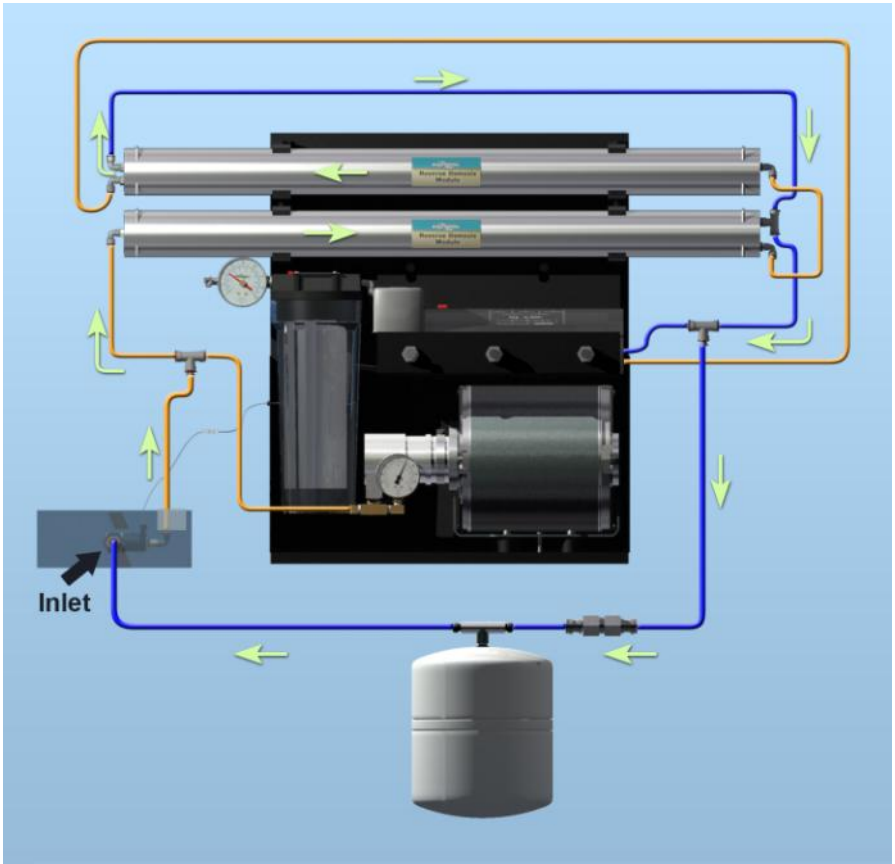

OPTIONAL INSTALLATIONS

D1. PURE WATER BLANKET

Identify a space to place the Pure Water Blanket. The PWB can be placed on the floor for convenience, preferably in close proximity to the main assembly. This will ensure that the tubing is kept to a minimum and is neatly arranged.

Mount the PWB Solenoid Assembly next to the 100+/1200+ system as shown.

The feed line passes through a tee between the RO Module and the 100+ SED pre-filter.

- 1) Attach a length of tubing from the outlet of the Pure Water Blanket Solenoid to the tube connection on the feed line tee as shown.

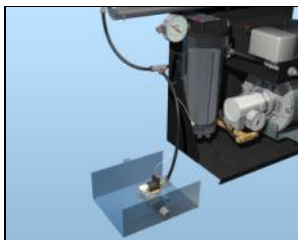

D1: Connect PWB outlet to feed line

The product line passes from the RO Modules to the tank outlet on the main frame.

- 2) Attach a length of tubing from the tube connection on the product line tee to the inlet check valve of the Pure Water Blanket Holding Tank as shown.



D2: Connect PWB tank inlet to product line and tank outlet to inlet on the PWB Solenoid

Note flow direction on the check valve is into the tank.

- 3) Connect the outlet of the PWB holding tank to the inlet of the Pure Water Blanket Solenoid inlet.

The main frame has a jack in order to be connected to the Pure Water Blanket.

- 4) Plug the PWB Solenoid jack to the PWB jack on the main frame as shown (labeled on unit as optional Pure Water Blanket).

Make sure all connections are secure. Also, be certain that there is no excessive tubing that may create a kink in the lines.

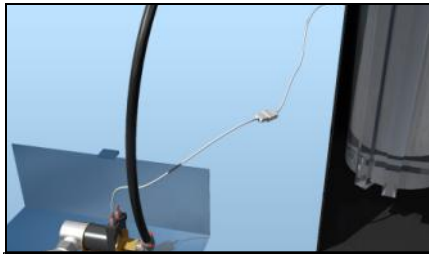

D3: Connect PWB jack

The Pure Water Blanket is now ready for operation. Follow the start up procedure for your 100+ or 1200+ system.

**D2. TYPICAL LAB DISPENSING
INSTALLATION**

Use Aquathin 100+/1200+ series, TXF series, or PPVM series when larger volumes of water are needed. Observe pretreatment requirements.



**SYN_K WATER
SOFTENER**



**SYNBF CARBON
FILTER**



**100+ / 1200+
SERIES**

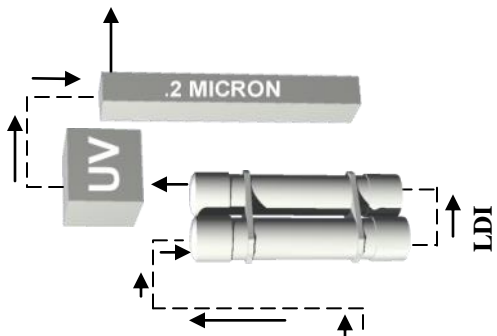



TANKS—SPECIFICATIONS AND DIMENSIONS

Model No.	NPTM System Conn.	Width	Height	Ship weight (pounds)	Total Volume (Gallons)	Usable Volume (Gallons)
RO-3	1/4"	9"	14"	6	3.0	2.0
RO-4	1/4"	11"	15"	9	4.4	2.82
RO-14	1/4"	15 3/8"	22 3/4"	25	14.0	8.96
RO-20	1"	15 3/8"	31 3/4"	35	20.0	12.80
RO-34	1 1/4"	22"	30"	48	34.0	20.48
RO-44	1 1/4"	22"	35 5/8"	70	44.0	28.16
RO-86	1 1/4"	26"	47 3/16"	130	86.0	55.04

Other parts:

TANK SANITIZER
 COUPLER ASSEMBLY
 (with aerator)

TANK PRESSURIZED
 TEST LED

TANK STAND

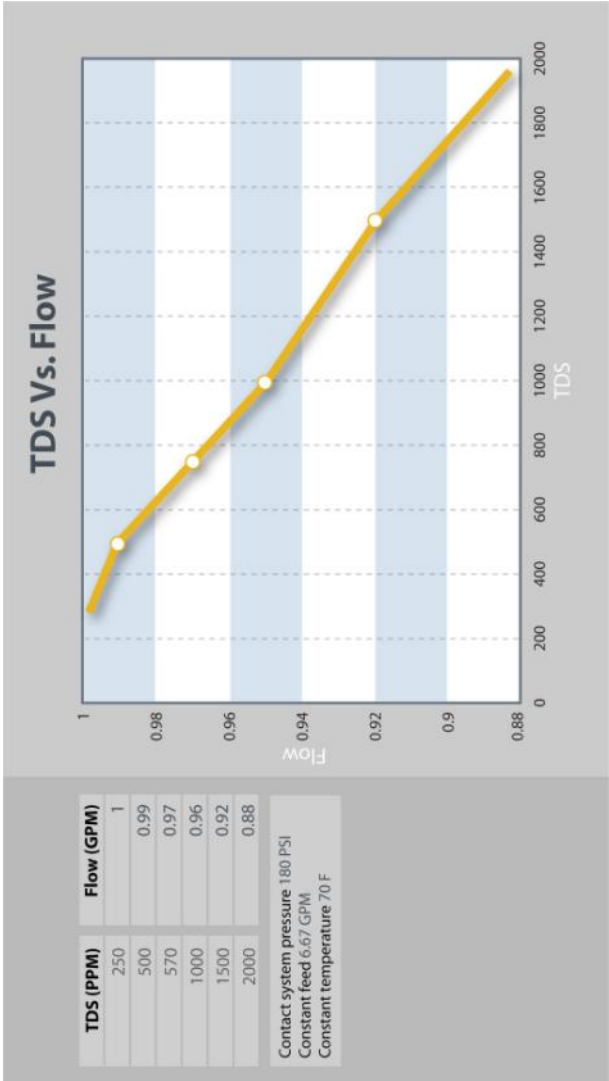

TEMPERATURE CORRECTION FACTOR

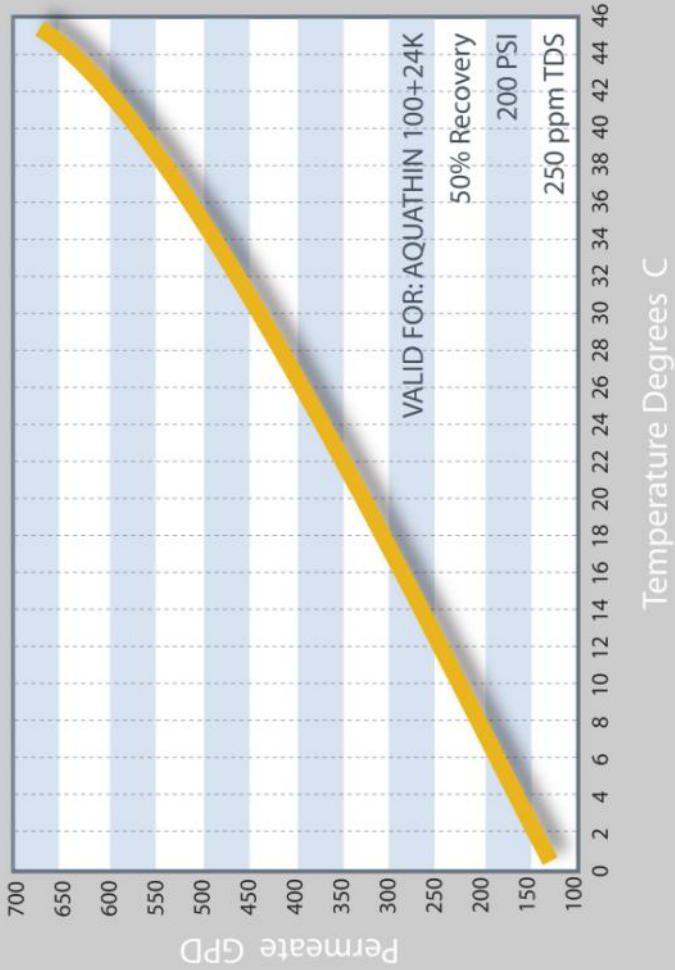

www.aquathin.com



35 Years Pure Excellence

www.aquathin.com



ISO 9001:2008
CERTIFIED



7 Patents Earned



8 Trademarks



Over 70 Systems



The Blue Chip
Enterprise
Award



**75% of the Earth
is covered by it**

**75% of the
human body
is made of it**

aquathin

**Aquathin
purifies 100%
of it.**

aquathin USA

*Purifying the Waters of the World
for the Best Taste in Life!*



EPA EST. NO. 52531-FL-01